

CENNIK PRODUKTÓW FUWK KONWEKTOR SP. Z O.O.

2021



WENTYLATORY

WENTYLATORY DACHOWE JEDNOBIEGOWE: WVPK(O)H(V)



TYP	OBROT SILNIKA	ZASILANIE	MOC [kW]	CENA NETTO (zł) (Wykonanie: Stalowe-malowane)		CENA NETTO (zł) (Wykonanie: kwasoodporne)	
				H	V	H	V
WVPK(O)-160	1400	400 V	0,18	1 900	2 038	2 718	3 044
WVPK(O)-160	900	400 V	0,09	1 900	2 038	2 718	3 044
WVPK(O)-160	700	400 V	0,09	1 946	2 071	2 718	3 044
WVPK(O)-160	1400	230 V	0,18	1 967	2 103	2 718	3 044
WVPK(O)-200	1400	400 V	0,37	2 040	2 248	3 012	3 445
WVPK(O)-200	900	400 V	0,18	2 040	2 247	3 012	3 445
WVPK(O)-200	700	400 V	0,09	2 123	2 314	3 012	3 445
WVPK(O)-200	1400	230 V	0,37	2 118	2 279	3 012	3 445
WVPK(O)-250	1400	400 V	0,55	2 427	2 626	3 438	3 970
WVPK(O)-250	900	400 V	0,25	2 420	2 612	3 438	3 970
WVPK(O)-250	700	400 V	0,12	2 462	2 665	3 438	3 970
WVPK(O)-250	1400	230 V	0,55	2 520	2 698	3 438	3 970
WVPK(O)-315	1400	400 V	0,75	2 795	3 166	4 216	5 019
WVPK(O)-315	900	400 V	0,37	2 795	3 166	4 216	5 019
WVPK(O)-315	700	400 V	0,18	2 844	3 212	4 216	5 019
WVPK(O)-315	1400	230 V	0,75	2 881	3 262	4 216	5 019
WVPK(O)-400	1400	400 V	1,5	4 340	4 733	5 577	6 529
WVPK(O)-400	900	400 V	0,75	4 293	4 670	5 577	6 529
WVPK(O)-400	700	400 V	0,37	4 293	4 670	5 577	6 529
WVPK(O)-400	1400	230 V	1,5	4 420	4 770	5 577	6 529
WVPK(O)-500	900	400 V	3	6 599	6 935	9 539	10 296
WVPK(O)-500	700	400 V	1,1	6 169	6 614	9 539	10 296
WVPK(O)-630	900	400 V	5,5	8 903	9 585	10 751	12 568
WVPK(O)-630	700	400 V	3	8 040	8 722	10 751	12 568
WVPK(O)-710	900	400 V	7,5	10 584	11 644	13 930	15 899
WVPK(O)-710	700	400 V	4	9 615	10 508	13 930	15 899

Płyta podstawy: K - kwadratowa; O - ośmiokątna

Wylot: H - poziomy; V - pionowy

WENTYLATORY DACHOWE DWUBIEGOWE: WVPK(O)H(V)



TYP	OBROT SILNIKA	ZASILANIE	MOC [kW]	CENA NETTO (zł) (Wykonanie: Stalowe-malowane)		CENA NETTO (zł) (Wykonanie: kwasoodporne)	
				H	V	H	V
WVPK(O)-160	1400/900	400 V	0,25/0,18	2 333	2 477	3 083	3 441
WVPK(O)-160	1400/700	400 V	0,18/0,06	2 383	2 585	3 134	3 502
WVPK(O)-200	1400/900	400 V	0,37/0,25	2 551	2 780	3 400	3 758
WVPK(O)-200	1400/700	400 V	0,40/0,22	2 669	2 871	3 475	3 850
WVPK(O)-250	1400/900	400 V	0,55/0,37	2 992	3 264	3 720	4 361
WVPK(O)-250	900/700	400 V	0,37/0,18	3 117	3 379	3 805	4 497
WVPK(O)-315	1400/900	400 V	0,75/0,25	3 478	3 953	4 557	5 945
WVPK(O)-315	900/700	400 V	0,37/0,18	3 609	4 035	4 664	6 064
WVPK(O)-400	1400/900	400 V	1,65/1,15	5 528	5 823	6 320	7 359
WVPK(O)-400	1400/700	400 V	1,60/0,90	5 479	5 889	6 405	7 427

Płyta podstawy: K - kwadratowa; O - ośmiokątna

Wylot: H - poziomy; V - pionowy

Ceny w PLN bez VAT, loco magazyn KONWEKTOR, Cennik nie stanowi oferty handlowej w rozumieniu art. 66 par.1 Kodeksu Cywilnego, nie stanowi zapewnienia, w szczególności w rozumieniu art. 556 Kodeksu Cywilnego. Cennik może zawierać błędy. Zastrzegamy sobie prawo do zmiany cen.

CENNIK PRODUKTÓW FUWK KONWEKTOR SP. Z O.O.

2021



WENTYLATORY DACHOWE/EX : WVPK(O)H(V)



TYP	OBROTY SILNIKA	ZASILANIE	MOC [kW]	CENA NETTO (zł)		CENA NETTO (zł)	
				H	V	H	V
WVPK(O)-160/EX	1400	400 V	0,18	3 207	3 346	4 371	4 632
WVPK(O)-160/EX	900	400 V	0,12	3 154	3 290	4 371	4 632
WVPK(O)-200/EX	1400	400 V	0,37	3 442	3 609	4 718	4 996
WVPK(O)-200/EX	900	400 V	0,25	3 442	3 609	4 718	4 996
WVPK(O)-250/EX	1400	400 V	0,55	3 942	4 230	5 083	5 464
WVPK(O)-250/EX	900	400 V	0,25	3 942	4 230	5 083	5 464
WVPK(O)-315/EX	1400	400 V	0,75	4 412	4 746	5 638	6 679
WVPK(O)-315/EX	900	400 V	0,37	4 124	4 534	5 551	6 592
WVPK(O)-315/EX	700	400 V	0,18	4 170	4 518	5 551	6 592
WVPK(O)-400/EX	1400	400 V	1,5	5 762	6 050	7 806	8 500
WVPK(O)-400/EX	900	400 V	0,75	5 383	5 792	7 442	8 188
WVPK(O)-400/EX	700	400 V	0,37	5 913	6 292	7 806	8 500
WVPK(O)-500/EX	900	400 V	3	-	-	11 969	13 010
WVPK(O)-500/EX	700	400 V	0,95	-	-	12 490	13 531
WVPK(O)-630/EX	900	400 V	5,5	-	-	14 745	16 827
WVPK(O)-630/EX	700	400 V	2,6	-	-	16 306	18 388
WVPK(O)-710/EX	900	400 V	5,5	-	-	19 082	21 510
WVPK(O)-710/EX	700	400 V	2,6	-	-	20 643	23 072

Płyta podstawy: K - kwadratowa; O - ośmiokątna

Wylot: H - poziomy; V - pionowy

WENTYLATORY: WVPB



TYP	OBROTY SILNIKA	ZASILANIE	MOC [kW]	CENA NETTO (zł)
WVPB-160	1 400	400 V	0,12	2 156
WVPB-160	1 400	230 V	0,12	2 219
WVPB-200	1 400	400 V	0,18	2 350
WVPB-200	1 400	230 V	0,18	2 406
WVPB-250	1 400	400 V	0,37	2 558
WVPB-250	900	400 V	0,25	2 463
WVPB-250	1 400	230 V	0,37	2 603
WVPB-315	1 400	400 V	0,55	3 151
WVPB-315	900	400 V	0,37	3 117
WVPB-315	1 400	230 V	0,55	3 234

WENTYLATORY OSIOWE DACHOWE: WOD

Wykonanie wyciągowe (WODW) i nawiewne (WODN)

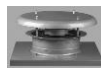

TYP	OBROTY SILNIKA	ZASILANIE	MOC [kW]	CENA NETTO (zł)
WOD (N/W) - 315	1400	230 V	0,07	1 688
WOD (N/W) - 355	1400	230 V	0,14	1 924
WOD (N/W) - 400	1400	230 V	0,195	2 303
WOD (N/W) - 450	1400	230 V	0,345	2 886
WOD (N/W) - 500	1400	230 V	0,57	3 091
WOD (N/W) - 560	900	230 V	0,45	3 296
WOD (N/W) - 630	900	230 V	0,53	3 391
WOD (N/W) - 710	900	400 V	1,1	4 211
WOD (N/W) - 800	900	400 V	1,3	4 684

CENNIK PRODUKTÓW FUWK KONWEKTOR SP. Z O.O.

2021



WENTYLATORY: WDDW



TYP	OBROTY SILNIKA	ZASILANIE	MOC [kW]	CENA NETTO (zł)
WDDW-180	1250	230 V	0,38	3 943
WDDW-225	1150	230 V	0,65	4 416
WDDW-280	1120	230 V	1,52	5 994
WDDW-315	1120	230 V	3,1	7 098

WENTYLATORY: WR



TYP	OBROTY SILNIKA	ZASILANIE	MOC [kW]	CENA NETTO (zł)
WR-125	2400	230 V	0,058	738
WR-125	1400	230 V	0,028	708
WR-160	2700	230 V	0,115	1 116
WR-160	1400	230 V	0,04	965

PODSTAWY DACHOWE (TYPY: B, WVPKT, WVPKP)



TYP	B I	B II	B III	CENA NETTO (zł) WVPKT	CENA NETTO (zł) WVPKP	Wykonanie
160	248	386	623	1 115	708	Stalowe/malowane
	364	872	*	2 831	2 124	Kwasoodporne
200	271	421	740	1 212	772	Stalowe/malowane
	503	1 093	*	2 960	2 252	Kwasoodporne
250	339	485	769	1 566	997	Stalowe/malowane
	604	1 365	*	4 076	3 325	Kwasoodporne
315	424	582	922	1 716	1 066	Stalowe/malowane
	673	1 908	*	4 290	3 561	Kwasoodporne
400	515	677	1 000	2 252	1 287	Stalowe/malowane
	992	2 001	*	5 534	4 419	Kwasoodporne
500	885	1 202	1 543	3 840	1 780	Stalowe/malowane
	1 584	2 475	*	9 867	*	Kwasoodporne
630	986	1 330	1 803	4 076	2 156	Stalowe/malowane
	2 178	3 094	*	11 154	*	Kwasoodporne
710	1 111	1 499	2 032	4 592	2 430	Stalowe/malowane
	2 455	3 486	*	12 570	*	Kwasoodporne

* do wyceny

PRZEPUSTNICE JEDNOKIERUNKOWE: WVPPI

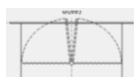

TYP	CENA NETTO (zł) (Wykonanie: Stalowe-malowane)	CENA NETTO (zł) (Wykonanie: Kwasoodporne)
160	254	554
200	294	611
250	321	680
315	340	792
400	425	904
500	499	1 181
630	642	1 650
710	804	2 178

CENNIK PRODUKTÓW FUWK KONWEKTOR SP. Z O.O.

2021



WENTYLATORY: WOK

Kierunek przepływu: SW-przepływ czynnika od strony silnika na wirnik

Kierunek przepływu: WS-przepływ czynnika od strony wirnika na silnik



TYP	OBROTY SILNIKA	ZASILANIE	MOC [kW]	CENA NETTO (zł) (Wersja : Krótka)		CENA NETTO (zł) (Wersja : Długa)	
				Wersja Stalowa	Wersja Kwasoodporna	Wersja Stalowa	Wersja Kwasoodporna
WOK-315	1400	400 V/230 V	0,2	1 087	1 954	1 468	2 638
WOK-315	900	400 V/230 V	0,25	981	2 013	1 362	2 795
WOK-355	2800	400 V	0,75	1 354	2 486	1 784	3 277
WOK-355	1400	400 V/230 V	0,2	1 293	2 368	1 723	3 157
WOK-355	900	400 V/230 V	0,25	1 141	2 427	1 571	3 344
WOK-400	2800	400 V/230 V	1,1	1 518	2 822	2 155	4 008
WOK-400	1400	400 V/230 V	0,2	1 628	2 861	2 266	3 982
WOK-400	900	400 V/230 V	0,25	1 441	2 940	2 078	4 242
WOK-500	2800	400 V	6	3 414	4 144	4 325	5 250
WOK-500	1400	400 V/230 V	0,75	2 258	3 453	3 168	4 847
WOK-500	900	400 V	0,18	2 104	3 375	3 014	4 836
WOK-630	1400	400 V	2,2	3 659	5 407	4 735	6 998
WOK-630	900	400 V	0,55	3 128	5 230	4 204	7 029
WOK-630	700	400 V	0,25	2 723	5 170	3 800	7 214
WOK-710	1400	400 V/230 V	3	4 539	6 922	5 814	8 866
WOK-710	900	400 V	1,1	3 835	6 600	5 110	8 795
WOK-710	700	400 V	0,37	3 376	6 430	4 651	8 859
WOK-800	1400	400 V	5,5	5 560	8 737	7 009	11 014
WOK-800	900	400 V	2,2	4 274	9 380	5 723	12 560
WOK-800	700	230 V	0,75	4 009	8 416	5 458	11 457
WOK-1000	900	400 V	4	7 338	11 914	*	*
WOK-1000	700	400 V	2,2	6 751	11 347	*	*
WOK-1110	1400	400 V	30	18 155	*	*	*

WENTYLATORY OSIOWE KANAŁOWE DWUBIEGOWE

Kierunek przepływu: SW-przepływ czynnika od strony silnika na wirnik

Kierunek przepływu: WS-przepływ czynnika od strony wirnika na silnik



TYP	OBROTY SILNIKA	ZASILANIE	MOC [kW]	CENA NETTO (zł)
WOK-500	2800/1400	400 V	5,2/1,3	3 734
WOK-500	1400/900	400 V	0,75/0,25	2 861
WOK-630	1400/900	400 V	1,65/1,15	4 499
WOK-630	1400/700	400 V	1,6/0,9	3 947
WOK-630	1400/900/700	400 V	2,1/1,5/1,2	5 644
WOK-710	1400/900	400 V	3,4/1,2	5 825
WOK-710	1400/700	400 V	4/1	5 447
WOK-710	1400/900/700	400 V	3/2/1,6	6 430
WOK-800	1400/900	400 V	4,5/1,7	6 770
WOK-800	1400/700	400 V	5,3/1,4	6 581

CENNIK PRODUKTÓW FUWK KONWEKTOR SP. Z O.O.

2021



WENTYLATORY: WOK/EX

Kierunek przepływu: SW-przepływ czynnika od strony silnika na wirnik

Kierunek przepływu: WS-przepływ czynnika od strony wirnika na silnik



TYP	OBROTY SILNIKA	ZASILANIE	MOC [kW]	CENA NETTO (zł)
WOK-315/EX	1400	400 V	0,18	2 908
WOK-355/EX	1400	400 V	0,2	3 352
WOK-355/EX	900	400 V	0,18	3 164
WOK-400/EX	1400	400 V	0,25	3 774
WOK-400/EX	900	400 V	0,18	3 508
WOK-500/EX	1400	400 V	0,75	5 928
WOK-500/EX	900	400 V	0,25	5 217
WOK-630/EX	1400	400 V	2,2	8 481
WOK-630/EX	900	400 V	0,55	7 726
WOK-710/EX	1400	400 V	3	9 546
WOK-710/EX	900	400 V	1,1	8 947
WOK-800/EX	1400	400 V	5,5	12 743
WOK-800/EX	900	400 V	2,2	11 189
WOK-1000/EX	900	400 V	7	17 539

WENTYLATORY: WOK-TS - WENTYLATORY OSIOWE KANAŁOWE WIRNIK Z TWORZYWA

Kierunek przepływu: SW-przepływ czynnika od strony silnika na wirnik

Kierunek przepływu: WS-przepływ czynnika od strony wirnika na silnik



TYP	OBROTY SILNIKA	ZASILANIE	MOC [kW]	CENA NETTO (zł) (Wersja : Krótka)	CENA NETTO (zł) (Wersja : Długi)
WOKTS-315	1400	230 V	0,2	1 586	1 889
WOKTS-315	900	230 V	0,18	1 586	1 889
WOKTS-315	2800	400 V	0,55	1 737	2 040
WOKTS-315	1400	400 V	0,2	1 586	1 889
WOKTS-315	900	400 V	0,25	1 661	1 965
WOKTS-355	1400	230 V	0,2	1 642	1 985
WOKTS-355	900	230 V	0,18	1 623	1 967
WOKTS-355	2800	400 V	0,75	1 850	2 193
WOKTS-355	1400	400 V	0,2	1 642	1 985
WOKTS-355	900	400 V	0,25	1 718	2 061
WOKTS-400	2800	230 V	1,1	2 567	3 075
WOKTS-400	1400	230 V	0,2	2 076	2 585
WOKTS-400	900	230 V	0,18	1 906	2 415
WOKTS-400	2800	400 V	1,1	2 567	3 075
WOKTS-400	1400	400 V	0,2	2 076	2 585
WOKTS-400	900	400 V	0,25	1 963	2 471
WOKTS-500	1400	230 V	0,75	2 435	3 161
WOKTS-500	2800	400 V	6	4 492	5 218
WOKTS-500	1400	400 V	0,75	2 435	3 161
WOKTS-500	900	400 V	0,18	2 114	2 840
WOKTS-630	1400	400 V	2,2	3 737	4 595
WOKTS-630	900	400 V	0,55	3 379	4 237
WOKTS-630	700	400 V	0,25	3 190	4 048
WOKTS-630	900	230 V	0,55	3 454	4 312
WOKTS-710	1400	400 V/230 V	3	5 078	6 094
WOKTS-710	900	400 V/230 V	1,1	4 379	5 396
WOKTS-710	700	400 V	0,37	3 945	4 961
WOKTS-800	1400	400 V	5,5	6 399	7 554
WOKTS-800	900	400 V	2,2	5 474	6 629
WOKTS-800	700	400 V	0,75	4 530	5 685
WOKTS-1000	900	400 V	4	7 701	8 472
WOKTS-1000	700	400 V	2,2	7 116	7 828
WOKTS-1000	1400	400V	11,00	8 531	9 384
WOKTS-1110	1400	400 V	3	18 121	19 933

CENNIK PRODUKTÓW FUWK KONWEKTOR SP. Z O.O.

2021



ELEMENTY DODATKOWE DO WENTYLATORÓW WOK

TYP	KANAŁ REWIZYJNY WOKR	KRÓCIEC WOE	RAMKA WOR	NOGA WON	SIATKA KONFUZ. WOKS	SIATKA WOS	DYSZA KONFUZ. WOKD
WOK-315	331	169	106	45	115	99	202
WOK-355	374	205	119	54	137	106	220
WOK-400	554	266	151	54	184	144	284
WOK-500	792	346	220	63	241	194	374
WOK-630	936	432	252	72	277	220	407
WOK-710	1 109	493	288	79	331	259	482
WOK-800	1 260	536	320	90	403	288	576

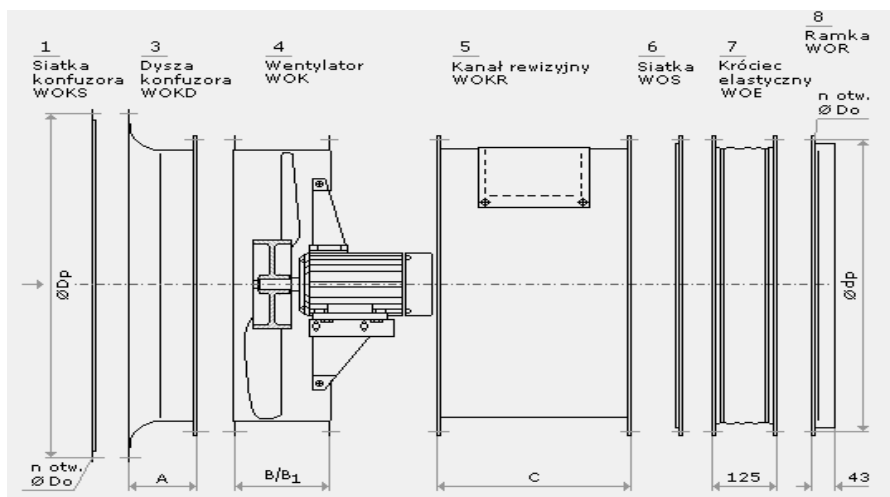

WENTYLATORY OSIOWE: WWS



TYP	OBROTNY SILNIKA	ZASILANIE	MOC [kW]	CENA NETTO (zł)
WWS-25	1400	230 V	0,01	758
WWS-30	1400	230 V	0,04	933
WWS-35,5	1400	230 V	0,04	1 064
WWS-40	1400	230 V	0,195	1 288
WWS-45	1400	230 V	0,345	1 606
WWS-50	1400	230 V	0,57	1 953
WWS-50	900	230 V	0,25	1 979
WWS-56	1300	400 V	1,05	2 742
WWS-56	900	230 V	0,45	2 617
WWS-63	1400	400 V	1,9	3 352
WWS-63	900	230 V	0,53	2 472
WWS-71	1400	400 V	2,9	4 161
WWS-71	900	400 V	1,1	3 589
WWS-80	900	400 V	1,3	4 559
WWS-80	700	400 V	0,85	4 467

ZESTAWY WENTYLACYJNE DACHOWE - ZWD

TYP	CENA NETTO (zł)		CENA NETTO (zł)	
	Wykonanie	Wykonanie	Wykonanie	Wykonanie
ZWD-315	stalowe	4 083	stalowe EX	6 722
ZWD-400	stalowe	5 350	stalowe EX	8 240
ZWD-630	stalowe	6 899	stalowe EX	10 625
	kwasoodporne	6 547	kwasoodporne EX	8 766
	kwasoodporne	9 152	kwasoodporne EX	11 771
	kwasoodporne	12 250	kwasoodporne EX	15 178



CENNIK PRODUKTÓW FUWK KONWEKTOR SP. Z O.O.

2021



TYP	OBROTY SILNIKA	ZASILANIE	MOC [kW]	CENA NETTO (zł) Wykonanie stalowe	CENA NETTO (zł) Wykonanie kwasoodporne	CENA NETTO (zł) Wykonanie aluminiowe
WO-20/W	1400	230 V	0,016	321	do wyceny	401
WO-25/W	1400	230 V	0,02	357	do wyceny	450
WO-30/W	1400	230 V	0,025	398	do wyceny	513
WO-40/W	1400	230 V/400 V	0,18/0,37	1 035	1 216	do wyceny
WO-50/W	900	400 V	0,25	1 134	1 366	do wyceny
WO-50/W	1400	230 V/400 V	0,55	1 213	1 437	do wyceny
WO-20/WS	1400	230 V	0,16	616	do wyceny	do wyceny

WENTYLATORY: WO/EX



TYP	OBROTY SILNIKA	ZASILANIE	MOC [kW]	CENA NETTO (zł)
WO-40/EX	1400	400 V	0,12	2 573
WO-50/EX	1400	400 V	0,55	3 056

ŻALUZJE DO WENTYLATORÓW: KWADRATOWE I OKRĄGŁE

TYP	A (SZER.)	B (WYS.)	D (wylot wew.)	CENA NETTO (zł)
ŻALUZJA WO-20/W	266	268	207	150
ŻALUZJA WO-25/W	364	344	262	172
ŻALUZJA WO-30/W	364	382	313	189
ŻALUZJA WO-40/W	505	472	400	243
ŻALUZJA WO-50/W	605	586	500	325
ŻALUZJA FI 630				563
ŻALUZJA FI 710				765
ŻALUZJA FI 800				910

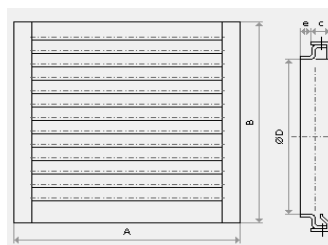

WENTYLATORY: WB



TYP	OBROTY SILNIKA	ZASILANIE	MOC [kW]	CENA NETTO (zł) wersja ocynkowana	CENA NETTO (zł) wersja kwasoodporna
WB-180	2800	400 V	1,5	1 720	1 879
WB-180	1400	400 V	0,37	1 436	1 753
WB-225	1400	400 V	0,37	1 603	2 238
WB-280	1400	400 V	1,5	2 722	3 340
WB-280	900	400 V	0,55	2 321	2 989
WB-315	1400	400 V	3	3 173	3 841
WB-315	900	400 V	0,75	2 805	3 507
WB-355	1400	400 V	4	3 507	4 392
WB-355	900	400 V	1,1	3 173	4 158
WB-400	900	400 V	2,2	3 957	5 277
WB-450	900	400 V	4	4 475	6 512
WB-500	900	400 V	5,5	5 611	8 182

CENNIK PRODUKTÓW FUWK KONWEKTOR SP. Z O.O.

2021



WENTYLATORY: WB/EX



TYP	OBROTY SILNIKA	ZASILANIE	MOC [kW]	CENA NETTO (zł) wersja ocynkowana	CENA NETTO (zł) wersja kwasoodporna
WB-180/EX	2800	400 V	1,5	3 148	3 703
WB-180/EX	1400	400 V	0,37	2 406	3 227
WB-225/EX	1400	400 V	0,37	3 049	4 257
WB-280/EX	1400	400 V	1,5	5 623	7 286
WB-280/EX	900	400 V	0,55	3 643	6 079
WB-315/EX	1400	400 V	3	6 692	8 593
WB-315/EX	900	400 V	0,75	5 485	7 346
WB-355/EX	1400	400 V	4	8 435	10 692
WB-355/EX	900	400 V	1,1	6 395	8 514
WB-400/EX	900	400 V	2,2	8 633	11 029
WB-450/EX	900	400 V	4	10 494	12 870

WENTYLATORY: WBK



TYP	OBROTY SILNIKA	ZASILANIE	MOC [kW]	CENA NETTO (zł) wersja ocynkowana	CENA NETTO (zł) wersja kwasoodporna
WBK-180	2800	400 V	7,5	1 703	2 062
WBK-180	1400	400 V	0,37	1 419	1 837
WBK-225	1400	400 V	0,37	1 970	2 505
WBK-280	1400	400 V	1,5	2 855	3 373
WBK-280	900	400 V	0,55	2 471	3 089
WBK-315	1400	400 V	3	3 206	3 874
WBK-315	900	400 V	0,75	2 855	3 590
WBK-355	1400	400 V	4	3 590	4 508
WBK-355	900	400 V	1,1	3 256	4 124
WBK-400	900	400 V	2,2	4 488	do wyceny
WBK-450	900	400 V	4	5 076	6 930

WENTYLATORY: WBK/EX



TYP	OBROTY SILNIKA	ZASILANIE	MOC [kW]	CENA NETTO (zł) wersja kwasoodporna
WBK-180/EX	2800	400 V	1,5	3 443
WBK-180/EX	1400	400 V	0,37	2 678
WBK-225/EX	1400	400 V	0,37	3 461
WBK-280/EX	1400	400 V	1,5	5 046
WBK-280/EX	900	400 V	0,55	4 317
WBK-315/EX	1400	400 V	3	6 011
WBK-315/EX	900	400 V	0,75	5 173
WBK-355/EX	1400	400 V	4	7 651
WBK-355/EX	900	400 V	1,1	6 631

CENNIK PRODUKTÓW FUWK KONWEKTOR SP. Z O.O.

2021



WENTYLATORY: WBD



TYP	OBROTY SILNIKA	ZASILANIE	MOC [kW]	CENA NETTO (zł)	CENA NETTO (zł)
				wersja ocynkowana	wersja kwasoodporna
WBD-180	1400	400 V	0,55	1 812	3 171
WBD-225	1400	400 V	0,75	2 430	3 896
WBD-280	1400	400 V	1,1	3 683	5 772
WBD-315	1400	400 V	2,2	4 158	6 882
WBD-355	1400	400 V	3	4 891	7 754
WBD-400	1400	400 V	5,5	5 900	9 649
WBD-450	1400	400 V	7,5	6 653	11 543
WBD-500	900	400 V	7,5	8 633	15 246
WBD-500	1400	400 V	15	9 662	17 006

WENTYLATORY: WBS



TYP	OBROTY SILNIKA	ZASILANIE	MOC [kW]	CENA NETTO (zł)
WBS-1	2800	230 V/400 V	0,055	762
WBS-2	2800	230 V/400 V	0,37	705
WBS-3	1400	230 V	0,15	505
WBS-3A	2120	230 V	0,242	387
WBS-4	2800	230 V	0,37	653
WBS-5	1500	230 V	0,105	242
WBS-5A	2000	230 V	0,176	268
WBS-6	2400	230 V	0,08	229
WBS-6L	2300	230 V	0,35	211
WBS-6A	2300	230 V	0,35	229
WBS-7	2500	230 V	0,06	237

WENTYLATORY HDD, HF oraz STEROWNIK HSW

MODEL	CENA NETTO (zł)
HF-150P	319
HF-200P	404
HF-250P	780
HF-315P	851
HDD-100/125P	376
HDD-150P	439
HDD-200P	709
STEROWNIK HSW-1	71



WENTYLATORY ODDYMIAJĄCE: WVP/OD, WOK/OD

TYP	OBROTY SILNIKA	ZASILANIE	MOC [kW]	CENA NETTO (zł)
Wentylator dachowy - oddymiający				
WVP-500/OD	900	400 V	3	8 368
WVP-630/OD	900/700	400 V	6,5/2,9	11 157
WVP-710/OD	700	400 V	7,5	11 400
Wentylator osiowy kanałowy - oddymiający				
WOK-500/OD	1400	400 V	1,1	6 521
WOK-630/OD	1400	400 V	3	8 930
WOK-710/OD	1400	400 V	4	10 002



WENTYLATORY PROMIENIOWE: WP-7,6



TYP	OBROTY SILNIKA	ZASILANIE	MOC [kW]	CENA NETTO (zł)	CENA NETTO (zł)
				wersja ocynkowana	wersja kwasoodporna
WP-7,6	2800	230 V	0,55	1 597	2 832
WP-7,6	2800	400 V	0,55	1 547	2 762

CENNIK PRODUKTÓW FUWK KONWEKTOR SP. Z O.O.

2021



WENTYLATORY PROMIENIOWE: WP

TYP	OBROTY SILNIKA	ZASILANIE	MOC [kW]	CENA NETTO (zł)
WP-250	2800	400 V	0,55	2 101
WP-250	2800	230 V	0,55	2 168
WP-300	2800	400 V	0,37	2 207
WP-300	2800	230 V	0,37	2 290
WP-355	2800	400 V	0,75	3 475
WP-355	2800	230 V	0,75	3 756
WP-450	2900	400 V	4	5 493
WP-630	2900	400 V	7,5	7 942



WENTYLATORY TRANSPORTOWE: WPT

TYP	OBROTY SILNIKA	ZASILANIE	MOC [kW]	CENA NETTO (zł)
WPT-100	2800	230 V	0,55	1 504
WPT-100	2800	400 V	0,55	1 440
WPT-250	2800	230 V	0,75	1 676
WPT-250	2800	400 V	0,75	1 495
WPT-280 a	2800	230 V	1,1	1 840
WPT-280 a	2800	400 V	1,1	1 753
WPT-280	2800	230 V	1,5	2 043
WPT-280	2800	400 V	1,5	1 963
WPT-315	2800	400 V	2,2	2 139
WPT-500	2800	400 V	4	3 119
WPT-700	2800	400 V	7,5	5 234



WENTYLATORY PROMIENIOWE: WPP

TYP	OBROTY SILNIKA	ZASILANIE	MOC [kW]	CENA NETTO (zł)
WPP-180	2800	400 V	0,55	1 397
WPP-225	2800	400 V	0,75	1 868
WPP-280	2800	400 V	1,1	2 863
WPP-315	2800	400 V	1,5	3 107
WPP-355	2800	400 V	1,5	3 596
WPP-400	1400	400 V	0,75	3 701
WPP-450	1400	400 V	1,1	3 998
WPP-500	1400	400 V	1,5	4 958



WENTYLATORY PROMIENIOWE: WPO

TYP	OBROTY SILNIKA	ZASILANIE	MOC [kW]	CENA NETTO (zł)
WPO-10	2780	400 V	1,1	3 748
	1400	400 V	0,55	3 610
WPO-12	2855	400 V	2,2	5 824
	1390	400 V	0,75	5 659
WPO-14	2910	400 V	5,5	8 190
	1390	400 V	0,75	6 926
WPO-16	2920	400 V	7,5	9 454
	1410	400 V	1,5	8 104
WPO-18	2920	400 V	15	12 906
	1425	400 V	2,2	9 961

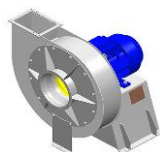

CENNIK PRODUKTÓW FUWK KONWEKTOR SP. Z O.O.

2021



WENTYLATORY KOMINKOWE

TYP	OBROTY SILNIKA	ZASILANIE	MOC [kW]	CENA NETTO (zł)
KO-300	1400	230 V	0,06	997
KO-600	900	230 V	0,076	1 203



WENTYLATORY PROMIENIOWE WWOax

WWOax 20 - 71 - Wentylatory promieniowe z napędem bezpośrednim lub sprzęgłowym

WWOax - wykonanie S235JR2 (St3S)

TYP WENTYLATORA	TYP SILNIKA	MOC SILNIKA [kW]	Cena z napędem bezpośrednim	Cena z napędem sprzęgłowym
WWOax-20	2SIE80-2A	0,75	2349	3 926
WWOax-22,4	2SIE80-2B	1,1	2469	4 252
WWOax-25	Sg80-4A	0,55	2661	4 306
	2SIE90-L2	2,2	2984	4 629
WWOax-28	Sg80-4A	0,55	2933	4 512
	2SIE80-2B	1,1	3085	4 663
	2SIE100L-2	3	3421	4 999
WWOax-31,5	2SIE112M-2	4		
	2SIE80-4B	0,75	3697	5 206
WWOax-35,5	2SIE132S-2A	5,5	4669	6 178
	Sg80-6B	0,55	4013	6 001
	2SIE90S-4	1,1	4209	6 198
	2SIE132S-2B	7,5	5230	7 218
WWOax-40	2SIE160M-2A	11	6120	8 108
	2SIE90S-6	0,75	4896	6 473
	2SIE90L-4	1,5	4901	6 478
	2SIE100L-4A	2,2	5056	6 633
WWOax-45	2SIE160M-2B	15	8539	11 009
	2SIE160L-2	18,5	9064	11 534
	2SIE90L-6	1,1	5271	7 808
	Sg100L-8A	0,75	5109	7 646
WWOax-50	2SIE100L-4B	3	5425	7 962
	2SIE112M-4	4	5588	8 125
	2SIE200L-2A	30	15459	18 887
	Sg100L-8A	0,75	5452	9 017
	2SIE112M-6	2,2	5866	9 431
WWOax-56	2SIE132S-4	5,5	6102	9 667
	2SIE132M-4	7,5	6277	9 843
	2SIE225M-2	45	18885	23 205
	Sg112M-8	1,5	6424	9 235
WWOax-63	2SIE132M-6A	4	7049	9 860
	2SIE160M-4	11	8019	10 830
	2SIE160L-4	15	8456	11 267
	Sg132M-8	3	8112	11 198
WWOax-71	2SIE132M-6B	5,5	8698	11 783
	2SIE160M-6	7,5	9394	12 479
	2SIE180M-4	18,5	11374	14 459
	2SIE180L-4	22	11669	14 754



CENNIK PRODUKTÓW FUWK KONWEKTOR SP. Z O.O.

2021**WWOax 63 - 125 - Wentylatory promieniowe z napędem sprzęgłowym lub pasowym**

WWOax - wykonanie S235JR2 (St3S)

TYP WENTYLATORA	TYP SILNIKA	MOC SILNIKA [kW]	Cena z napędem sprzęgłowym	Cena z napędem pasowym
WWOax-63	Sg132M-8	3		15 299
	2SIE132M6B	5,5		15 920
	2SIE160M-6	7,5		16 659
	2SIE160L-4	15		17 193
	2SIE180M-4	18,5		18 762
	2SIE180L-4	22		19 075
	2SIE200L-4	30		22 526
	2SIE225S-4	37		23 872
WWOax-71	2SIE160M-6	7,5	19803	20 319
	2SIE160L-6	11	20423	20 939
	2SIE160L-4	15	20336	20 852
	2SIE180M-4	18,5	21905	22 421
	2SIE180L-4	22	22218	22 734
	2SIE200L-4	30	25669	26 185
	2SIE225M-4	45	28705	29 221
WWOax-80	Sg160M-8B	5,5		22 239
	3Sg160L-8	7,5		22 536
	Sg180L-8	11	22356	23 929
	2SIE180L-6	15		25 561
	2SIE200L-6B	22	27311	28 884
	2SIE225S-4	37		30 337
WWOax-90	2Sg225S-8	18,5	7036	42 129
	2SIE225M-6	30	10718	45 646
	2SIE280S-6	45	15114	50 041
	2SIE280S-4	75	17160	52 254
WWOax-100	Sg180L8-M	11		42 160
	2Sg200L-8	15		45 431
	2Sg225M-8	22		46 906
	2SIE225M-6	30		49 684
	2Sg250M-8	30	52846	49 876
	2SIE280S-6	45	15114	54 080
	2SIE280M-6	55		55 796
	2SIE315S-6	75	61895	58 924
WWOax-112	2SIE280M4	90	96650	19 312
WWOax-125	2Sg315M-8A	75	130652	
	2SIE315M6D	160	37092	
		200		

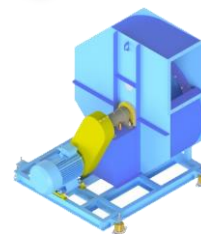

CENNIK PRODUKTÓW FUWK KONWEKTOR SP. Z O.O.

2021**WWOax/PW 20 P - 100 P - Wentylatory promieniowe przeciwybuchowe z napędem bezpośrednim lub pasowym**

wentylatory promieniowe WWOax P wg. PN-M-43026 z 1998 r.
przeciwybuchowe z atestem fabrycznym - wykonanie M63 + S235JR2 (St3S) strefa ExII 3G T3

TYP WENTYLATORA	TYP SILNIKA	MOC SILNIKA [kW]	Cena z napędem bezpośrednim	Cena z napędem pasowym
WWOax-20 P	ECSgb 90S2	1,5	5 194 zł	
WWOax-25 P	ECSgb 90S4	1,1	5 893 zł	
	ECSgb 90L2	2,2	6 184 zł	
WWOax-31,5 P	ECSgb 90S4	1,1	7 466 zł	
	ECSg 132S2A	5,5	10 198 zł	
WWOax-35,5 P	ECSgb 90S4	1,1	7 990 zł	
	EcSgb160M-2A-EP	11	12 278 zł	
WWOax-40 P	W-EF 90SG (6)	0,75	8 969 zł	
	W-EF 90LS (6)	1,1	9 240 zł	
	ECSgb 90L4	1,5	9 477 zł	
	ECSgb 100L4A	2,2	9 741 zł	
	EcSgb160M2B-EP	15	16 171 zł	
	EcSgb160L2-EP	18,5	16 620 zł	
WWOax-45 P	ECSgb 100L-4B	3	10 347 zł	
	EcSg200L2A-EP	30	21 224 zł	
WWOax-50 P	W-EF 100LS (8)	1,1	10 984 zł	
	W-EF112MK(6)	2,2	11 301 zł	
	ECSg 132S-4	5,5	12 548 zł	
	ECSg 132M-4	7,5	13 222 zł	
	EcSgb225M2-EP	45	25 037 zł	
WWOax-56 P	ECSg 112M-4	4	13 061 zł	
WWOax-63 P	W-EF 132MR(8)	3	15 979 zł	22 621
	W-EF 132MR(6)	5,5	16 388 zł	23 030
	EcSgb160M6-EP	7,5	17 107 zł	23 749
	EcSg180M4-EP	18,5	18 665 zł	25 307
	EcSg180L4-EP	22	19 272 zł	25 914
WWOax-80 P	EcSgb160M8B-EP	5,5		30 689
	EcSgb160L8-EP	7,5		32 233
	EcSg180L8-EP	11		33 514
	EcSg180L6-EP	15		33 131
	EcSg200L6B-EP	22		34 385
	EcSgb225S4-EP	37		37 355
WWOax-100 P	EcSg180L8-EP	11		65 927
	EcSg200L8-EP	15		66 864
	EcSgb225M8-EP	22		68 554
	EcSgb250M8-EP	30		72 699
	EcSgb280M6-EP	55		78 124

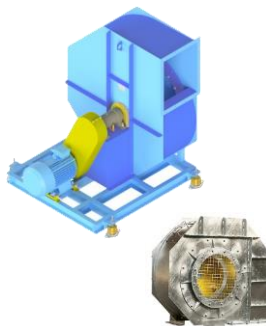

CENNIK PRODUKTÓW FUWK KONWEKTOR SP. Z O.O.

2021



WENTYLATORY: FK-20

		Napęd pasowy R/I do 130°C		Napęd pasowy R/IA do 130°C			
TYP WENTYLATORA		Napęd bezpośredni do 60°C		dla napędu R/I prędkość obrotowa wirnika jest ograniczona do: 1780 obr./min dla FK-31,5 1600 obr./min dla FK-40 1100 obr./min dla FK-50		przy wyższych prędkościach napęd R/IA lub R/IM	
Wykonanie		Obudowa i wirnik ST	Obudowa i wirnik H17T (KO)	Obudowa i wirnik ST	Obudowa i wirnik H17T (KO)	Obudowa i wirnik ST	Obudowa i wirnik H17T (KO)
typ	moc	CENY NETTO (zł)					
FK-20 0,25kW 900		3 258	6 344	5 769	8 357	6 708	8 912
FK-20 0,25kW 1400		3 316	6 536	5 616	8 146	6 536	8 836
FK-20 0,37kW 1400		3 316	6 536	5 750	8 318	6 612	8 912
FK-20 0,55kW 1400		3 316	6 536	5 769	8 357	6 708	8 912
FK-20 0,75kW 2900		3 277	6 344	5 769	8 357	6 708	8 912



		Napęd pasowy R/IF do 250°C		Napęd pasowy R/IC do 400°C	Napęd sprzęgłowy do 130°C				
TYP WENTYLATORA		do 250°C - wentylatory z napędem R/IF oraz I/F z odrzutnikiem ciepła		do 400°C - wentylatory z napędem R/IC lub I/C (z obudową łożysk chłodzoną wodą, obudową wentylatora i wirnika wykonanymi ze stali 0H17)					
Wykonanie		Obudowa i wirnik ST	Obudowa i wirnik H17T (KO)	Obudowa i wirnik H17T (KO)	Obud. Wirnik stal. łoż. A	Obud. Wirnik H17T (KO) łoż. A	Obud. Wirnik stal. łoż. F	Obud. Wirnik H17T (KO) łoż. F	Obud. Wirnik H17T (KO) łoż. C
typ	moc	CENY NETTO (zł)`							
FK-20 0,25kW 900		6 255	8 468	9 270	4 635	6 621	4 774	6 865	7 771
FK-20 0,25kW 1400		6 133	8 242	9 148	4 617	6 534	4 722	6 726	7 667
FK-20 0,37kW 1400		6 255	8 311	8 834	4 617	6 604	4 722	6 830	7 667
FK-20 0,55kW 1400		6 255	8 346	9 270	4 687	6 621	4 879	6 865	7 789
FK-20 0,75kW 2900		6 255	8 346	9 270	4 722	6 621	4 879	6 865	7 789

CENNIK PRODUKTÓW FUWK KONWEKTOR SP. Z O.O.

2021



WENTYLATORY: FK-25

	Napęd bezpośredni do 60°C		Napęd pasowy R/I do 130°C		Napęd pasowy R/IA do 130°C	
TYP WENTYLATORA			dla napędu R/I prędkość obrotowa wirnika jest ograniczona do: 1780 obr./min dla FK-31,5 1600 obr./min dla FK-40 1100 obr./min dla FK-50		przy wyższych prędkościach napęd R/IA lub R/IM	
Wykonanie	Obudowa i wirnik ST	Obudowa i wirnik H17T (KO)	Obudowa i wirnik ST	Obudowa i wirnik H17T (KO)	Obudowa i wirnik ST	Obudowa i wirnik H17T (KO)
typ moc obroty	CENY NETTO (zł)`					
FK-25 0,25kW 900	3 450	7 074	-	8 921	6 517	9 653
FK-25 0,37kW 900	-	-	5 820	9 008	6 656	9 583
FK-25 0,37kW 1400	-	-	5 698	8 851	6 499	9 444
FK-25 0,55kW 1400	3 450	7 074	5 732	8 921	6 517	9 514
FK-25 0,75kW 1400	-	-	5 802	8 939	6 586	9 548
FK-25 1,1kW 2900	-	-	5 820	9 008	6 656	9 635
FK-25 1,5kW 2900	-	-	6 064	9 217	6 848	9 810
FK-25 2,2kW 2900	3 903	7 214	6 133	9 287	6 970	10 001

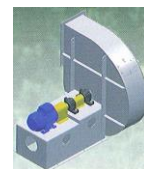
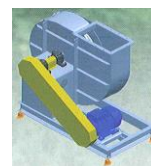

TYP	Napęd pasowy R/IF do 250°C		Napęd pasowy R/IC do 400°C	Napęd sprzęgłowy do 130°C				
TYP WENTYLATORA	do 250°C - wentylatory z napędem R/IF oraz I/F z odrzutnikiem ciepła		do 400°C - wentylatory z napędem R/IC lub I/C (z obudową łożysk chłodzoną wodą, obudową wentylatora i wirnika wykonanymi ze stali OH17)					
Wykonanie	Obudowa i wirnik ST	Obudowa i wirnik H17T (KO)	Obudowa i wirnik H17T (KO)	Obud. Wirnik stal. łoż. A	Obud. Wirnik H17T (KO) łoż. A	Obud. Wirnik stal. łoż. F	Obud. Wirnik H17T (KO) łoż. F	Obud. Wirnik H17T (KO) łoż. C
typ moc obroty	CENA NETTO (zł)							
FK-25 0,25kW 900	6 691	9 653	10 629	5 064	8 050	5 088	8 276	9 235
FK-25 0,37kW 900	6 848	9 810	10 733	-	-	-	-	-
FK-25 0,37kW 1400	6 673	9 635	10 594	-	-	-	-	-
FK-25 0,55kW 1400	6 691	9 653	10 646	5 070	8 050	5 123	8 346	9 270
FK-25 0,75kW 1400	6 830	9 810	10 698	-	-	-	-	-
FK-25 1,1kW 2900	6 848	9 879	10 733	-	-	-	-	-
FK-25 1,5kW 2900	7 022	9 984	10 925	-	-	-	-	-
FK-25 2,2kW 2900	7 109	10 158	11 099	5 576	8 695	5 645	8 834	9 792

CENNIK PRODUKTÓW FUWK KONWEKTOR SP. Z O.O.

2021



WENTYLATORY: FK-31,5

	Napęd bezpośredni do 60°C		Napęd pasowy R/I do 130°C		Napęd pasowy R/IA do 130°C	
TYP WENTYLATORA			dla napędu R/I prędkość obrotowa wirnika jest ograniczona do: 1780 obr./min dla FK-31,5 1600 obr./min dla FK-40 1100 obr./min dla FK-50		przy wyższych prędkościach napęd R/IA lub R/IM	
Wykonanie	Obudowa i wirnik ST	Obudowa i wirnik H17T (KO)	Obudowa i wirnik ST	Obudowa i wirnik H17T (KO)	Obudowa i wirnik ST	Obudowa i wirnik H17T (KO)
typ moc obroty	CENA NETTO (zł)					
FK-31,5 0,25kW 900	3 938	8 939	6 290	11 726	7 214	11 395
FK-31,5 0,37kW 1400	-	-	6 255	10 803	7 144	11 326
FK-31,5 0,55kW 1400	3 938	8 939	6 290	10 838	7 214	11 395
FK-31,5 0,75kW 1400	-	-	6 377	10 907	7 248	11 465
FK-31,5 1,1kW 1400	-	-	6 534	11 047	7 423	11 500
FK-31,5 1,5kW 1400	-	-	-	-	7 597	11 796
FK-31,5 2,2kW 2900	-	-	-	-	7 597	11 831
FK-31,5 3kW 2900	-	-	-	-	7 591	12 110
FK-31,5 4kW 2900	5 105	10 280	-	-	7 591	12 702

	Napęd pasowy R/IF do 250°C		Napęd pasowy R/IC do 400°C	Napęd sprzęgłowy do 130°C				
TYP WENTYLATORA	do 250°C - wentylatory z napędem R/IF oraz I/F z odrzutnikiem ciepła		do 400°C - wentylatory z napędem R/IC lub I/C (z obudową łożysk chłodzoną wodą, obudową wentylatora i wirnika wykonanymi ze stali 0H17)					
Wykonanie	Obudowa i wirnik ST	Obudowa i wirnik H17T (KO)	Obudowa i wirnik H17T (KO)	Obud. Wirnik stal. łoż. A	Obud. Wirnik H17T (KO) łoż. A	Obud. Wirnik stal. łoż. F	Obud. Wirnik H17T (KO) łoż. F	Obud. Wirnik H17T (KO) łoż. C
typ moc obroty	CENA NETTO (zł)							
FK-31,5 0,25kW 900	7 405	11 570	12 528	5 489	9 845	6 935	9 914	10 855
FK-31,5 0,37kW 1400	7 405	11 570	12 510	-	-	-	-	-
FK-31,5 0,55kW 1400	7 405	11 570	12 528	5 593	9 845	5 872	10 001	10 960
FK-31,5 0,75kW 1400	7 457	11 657	12 911	-	-	-	-	-
FK-31,5 1,1kW 1400	7 597	11 761	12 807	-	-	-	-	-
FK-31,5 1,5kW 1400	7 823	12 179	12 946	-	-	-	-	-
FK-31,5 2,2kW 2900	7 823	12 040	12 946	-	-	-	-	-
FK-31,5 3kW 2900	8 067	12 319	13 242	-	-	-	-	-
FK-31,5 4kW 2900	8 642	12 824	13 852	6 865	11 117	7 004	11 256	12 197

CENNIK PRODUKTÓW FUWK KONWEKTOR SP. Z O.O.

2021



WENTYLATORY: FK- 40

			Napęd bezpośredni do 60°C		Napęd pasowy R/I do 130°C		Napęd pasowy R/IA do 130°C	
TYP WENTYLATORA					dla napędu R/I prędkość obrotowa wirnika jest ograniczona do: 1780 obr./min dla FK-31,5 1600 obr./min dla FK-40 1100 obr./min dla FK-50		przy wyższych prędkościach napęd R/IA lub R/IM	
Wykonanie			Obudowa i wirnik ST	Obudowa i wirnik H17T (KO)	Obudowa i wirnik ST	Obudowa i wirnik H17T (KO)	Obudowa i wirnik ST	Obudowa i wirnik H17T (KO)
typ	moc	obroty	CENA NETTO (zł)					
FK-40 0,55kW 700			5 767	15 298	8 695	17 163	9 845	18 295
FK-40 0,55kW 900			-	-	8 433	16 779	9 548	17 929
FK-40 0,75kW 900			5 924	15 438	8 782	17 302	9 967	19 759
FK-40 1,1kW 1400			-	-	8 468	16 901	9 897	17 894
FK-40 1,5kW 1400			-	-	8 660	17 441	10 054	18 557
FK-40 2,2kW 1400			5 994	13 504	8 851	17 232	10 054	18 557
FK-40 3kW 1400			-	-	-	-	10 245	18 713
FK-40 4kW 1400			-	-	-	-	10 611	19 114
FK-40 7,5kW 1400			6 970	-	-	-	11 465	19 933
FK-40 11kW 2900			-	-	-	-	13 974	22 425
FK-40 15kW 2900			10 106	-	-	-	14 776	23 209
FK-40 18,5kW 2900			12 301	21 954	-	-	16 169	24 603

			Napęd pasowy R/IF do 250°C		Napęd pasowy R/IC do 400°C	Napęd sprzęgłowy do 130°C				
TYP WENTYLATORA			do 250°C - wentylatory z napędem R/IF oraz I/F z odrzutnikiem ciepła		do 400°C - wentylatory z napędem R/IC lub I/C (z obudową łóżysk chłodzoną wodą, obudową wentylatora i wirnika wykonanymi ze stali 0H17)					
Wykonanie			Obudowa i wirnik ST	Obudowa i wirnik H17T (KO)	Obudowa i wirnik H17T (KO)	Obud. Wirnik stal. łóż. A	Obud. Wirnik H17T (KO) łóż. A	Obud. Wirnik stal. łóż. F	Obud. Wirnik H17T (KO) łóż. F	Obud. Wirnik H17T (KO) łóż. C
typ	moc	obroty	CENA NETTO (zł)							
FK-40 0,55kW 700			10 141	18 278	19 410	8 015	16 152	8 224	16 152	17 389
FK-40 0,55kW 900			9 792	17 912	18 992	-	-	-	-	-
FK-40 0,75kW 900			10 245	18 382	19 410	8 120	16 344	7 492	16 326	17 581
FK-40 1,1kW 1400			9 845	17 982	19 132	-	-	-	-	-
FK-40 1,5kW 1400			10 298	18 452	19 585	-	-	-	-	-
FK-40 2,2kW 1400			10 298	18 452	19 585	8 276	17 982	8 433	16 379	17 633
FK-40 3kW 1400			10 524	18 679	19 759	-	-	-	-	-
FK-40 4kW 1400			10 855	19 044	20 160	-	-	-	-	-
FK-40 7,5kW 1400			11 709	19 916	20 978	-	-	-	-	-
FK-40 11kW 2900			14 166	22 372	23 488	-	-	-	-	-
FK-40 15kW 2900			14 967	23 174	24 219	-	-	-	-	-
FK-40 18,5kW 2900			16 448	24 585	25 718	14 305	22 512	14 566	22 512	23 749

CENNIK PRODUKTÓW FUWK KONWEKTOR SP. Z O.O.

2021



WENTYLATORY: FK- 50

			Napęd bezpośredni do 60°C		Napęd pasowy R/I do 130°C		Napęd pasowy R/IA do 130°C	
TYP WENTYLATORA					dla napędu R/I prędkość obrotowa wirnika jest ograniczona do: 1780 obr./min dla FK-31,5 1600 obr./min dla FK-40 1100 obr./min dla FK-50		przy wyższych prędkościach napęd R/IA lub R/IM	
Wykonanie			Obudowa i wirnik ST	Obudowa i wirnik H17T (KO)	Obudowa i wirnik ST	Obudowa i wirnik H17T (KO)	Obudowa i wirnik ST	Obudowa i wirnik H17T (KO)
typ	moc	obroty	CENA NETTO (zł)					
FK-50	0,75kW	700	-	-	10 472	24 620	11 639	25 439
FK-50	1,1kW	700	6 460	23 104	10 507	24 742	11 674	25 596
FK-50	1,5kW	900	-	-	10 245	24 411	11 117	25 247
FK-50	2,2kW	900	7 667	23 278	10 698	24 899	11 918	25 718
FK-50	4kW	1400	-	-	10 855	24 986	12 023	25 857
FK-50	5,5kW	1400	-	-	-	-	12 441	26 206
FK-50	7,5kW	1400	8 660	24 306	-	-	12 441	26 624
FK-50	11kW	1400	-	-	-	-	14 967	28 784
FK-50	15kW	1400	-	-	-	-	16 082	29 987
FK-50	22kW	1400	-	-	-	-	21 170	34 360

			Napęd pasowy R/IF do 250°C		Napęd pasowy R/IC do 400°C	Napęd sprzęgłowy do 130°C				
TYP WENTYLATORA			do 250°C - wentylatory z napędem R/IF oraz I/F z odrzutnikiem ciepła		do 400°C - wentylatory z napędem R/IC lub I/C (z obudową łóżysk chłodzoną wodą, obudową wentylatora i wirnika wykonanymi ze stali OH17)					
Wykonanie			Obudowa i wirnik ST	Obudowa i wirnik H17T (KO)	Obudowa i wirnik H17T (KO)	Obud. Wirnik stal. Łoż. A	Obud. Wirnik H17T (KO) Łoż. A	Obud. Wirnik stal. Łoż. F	Obud. Wirnik H17T (KO) Łoż. F	Obud. Wirnik H17T (KO) Łoż. C
typ	moc	obroty	CENA NETTO (zł)							
FK-50	0,75kW	700	12 145	25 700	27 234	-	-	-	-	-
FK-50	1,1kW	700	12 284	25 840	27 391	9 845	23 749	10 019	30 962	24 506
FK-50	1,5kW	900	11 674	25 509	27 042	-	-	-	-	-
FK-50	2,2kW	900	12 197	26 014	27 565	10 019	23 958	10 193	24 097	25 108
FK-50	4kW	1400	12 284	26 084	27 652	-	-	-	-	-
FK-50	5,5kW	1400	12 720	26 450	28 053	-	-	-	-	-
FK-50	7,5kW	1400	13 207	26 920	28 523	10 977	24 533	11 099	25 038	26 049
FK-50	11kW	1400	15 438	29 028	30 771	-	-	-	-	-
FK-50	15kW	1400	16 744	30 248	32 060	-	-	-	-	-
FK-50	22kW	1400	21 397	34 604	36 660	-	-	-	-	-

CENNIK PRODUKTÓW FUWK KONWEKTOR SP. Z O.O.

2021

WENTYLATORY PROMIENIOWE PRZECIWWYBUCHOWE: FKP

TYP	MOC [kW]	OBROTY SILNIKA	CENA NETTO (zł)
			Napęd bezpośredni do 50°C KO
FKP-20	0,75	900	8 660
FKP-20	1,10	1 400	8 172
FKP-20	1,50	2 900	8 294
FKP-25	0,75	900	9 287
FKP-25	1,10	1 400	8 939
FKP-25	2,20	2 900	9 461
FKP-31,5	0,75	900	11 883
FKP-31,5	1,10	1 400	11 326
FKP-31,5	4,00	2 900	15 612
FKP-40	0,55	700	16 762
FKP-40	0,75	900	16 361
FKP-40	2,20	1 400	17 563
FKP-50	1,10	700	23 888
FKP-50	2,20	900	24 934
FKP-50	7,50	1 400	27 025

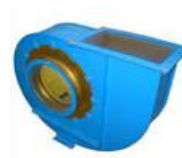

WENTYLATORY ODDYMIAJĄCE STRUMIENIOWE: WOG

TYP	CENA NETTO (zł)
WOG F400	
WOG ø315 F400	5 847
WOG ø355 F400	6 048
WOG ø400 F400	6 519



TŁUMIKI DO WENTYLATORA WOG

MODEL	CENA NETTO (zł)
Tłumik ø315	533
Tłumik ø355	599
Tłumik ø400	655

MODEL	CENA NETTO (zł)
Deflektor ø355	80
Deflektor ø355	82
Deflektor ø400	90

WENTYLATOR WOG + TŁUMIKI + DEFLEKTOR + SIATKA

MODEL	CENA NETTO (zł)
WOG 40°C	
WOG ø315 F40 z tłumikami + deflektor + siatka	3 291
WOG ø355 F40 z tłumikami + deflektor + siatka	4 250
WOG ø400 F40 z tłumikami + deflektor + siatka	5 789

CENNIK PRODUKTÓW FUWK KONWEKTOR SP. Z O.O.

2021



NEOLUX

TYP	OBROTY SILNIKA	ZASILANIE	MOC [kW]	CENA NETTO (zł)
NEOLUX III	MAX. 1140	230 V	0,077	2 600
NEOLUX IV	MAX. 1280	230 V	0,13	3 380



Elementy zamienne

Elementy zamienne				CENA NETTO (zł)
Nagrzewnica wodna - NEOLUX III				468
Nagrzewnica wodna - NEOLUX IV				515
Grzałki elektr. kpl (2 szt.) NEOLUX III				79
Grzałki elektr. kpl (2 szt.) NEOLUX IV				115
Wentylator WPN-10/480		230 V		1 273
Wentylator WPN-10/780		230 V		1 675
KANAŁ III - SKRZYŃKA CZERPNA				434
KANAŁ IV - SKRZYŃKA CZERPNA				498



URZĄDZENIE GRZEWCZO - WENTYLACYJNE: UGW

TYP	ZASILANIE	CENA NETTO (zł)
UGW-35,5	230 V	3 049
UGW-40	230 V	3 557
UGW-50	230 V	4 356
UGW-63	230 V	5 082
AGW-S40	230 V	4 066
AGW-S63	230 V	5 082



OGRZEWACZE ELEKTRYCZNE: OWE

TYP	ZASILANIE	CENA NETTO (zł)
OWE 2,4	230 V	733
OWE 6/3	400 V	1 873
OWE 12/6	400 V	2 468
OWE 18/9	400 V	3 020
OWE 28/14	400 V	4 240



ZESTAW GRZEWCZO-WENTYLACYJNY: ZGW

TYP	ZASILANIE	CENA NETTO (zł)
ZGW-1W/1	WODNE	2 020
ZGW-1W/2		2 317
ZGW-2W/1		2 435
ZGW-2W/2		3 604
ZGW-1P/1	PAROWE	2 059
ZGW-1P/2		2 495
ZGW-2P/1		2 614
ZGW-2P/2		3 722



NAGRZEWNICE: stalowe malowane

TYP	WODNA	PAROWA	TYP	WODNA	PAROWA
1/I	804	789	1/II	1 281	1 126
2/I	890	850	2/II	1 394	1 411
3/I	1 053	1 055	3/II	1 842	1 771
4/I	1 239	1 214	4/II	2 294	1 997
5/I	1 549	1 463	5/II	2 930	2 574
6/I	2 361	2 064	6/II	4 246	3 841
7/I	2 792	2 535	7/II	4 761	4 856
8/I	3 772	3 238	8/II	6 982	6 279
9/I	5 086	4 291	9/II	9 011	8 108
10/I	6 327	5 310	10/II	11 036	9 586
11/I	7 357	6 436	11/II	12 265	12 035
12/I	*	7 493	12/II	*	14 264

* ceny udzielane na zapytanie klienta



WYMIENNIKI CIEPŁA: stalowe malowane

TYP/EL.GRZ	6	10	16	25	40	63	100	160
I	689	905	1 345	1 702	2 092	2 791	4 274	5 376
II	801	1 109	1 706	2 162	2 853	3 944	5 826	8 589
III	887	1 271	2 032	2 583	3 493	5 065	8 188	11 992
IV	1 069	1 510	2 547	3 083	4 274	6 507	10 791	14 294

CENNIK PRODUKTÓW FUWK KONWEKTOR SP. Z O.O.

2021



NAGRZEWNICE: BIMETALOWE

TYP	WODNA	PAROWA	TYP	WODNA	PAROWA
1/I	636	624	1/II	1 013	891
2/I	704	672	2/II	1 103	1 116
3/I	833	835	3/II	1 457	1 401
4/I	980	960	4/II	1 815	1 580
5/I	1 225	1 158	5/II	2 318	2 037
6/I	1 868	1 633	6/II	3 360	3 039
7/I	2 209	2 005	7/II	3 767	3 842
8/I	2 984	2 562	8/II	5 524	4 968
9/I	4 024	3 395	9/II	7 129	6 415
10/I	5 006	4 201	10/II	8 732	7 584
11/I	5 821	5 092	11/II	9 704	9 522
12/I	*	5 928	12/II	*	11 286

WYMIENNIKI CIEPŁA - BIMETAL

TYP	6	10	16	25	40	63	100	160
I	545	716	1 064	1 346	1 655	2 208	3 382	4 254
II	634	878	1 350	1 711	2 257	3 120	4 609	6 795
III	702	1 006	1 608	2 043	2 764	4 008	6 479	9 488
IV	846	1 194	2 015	2 439	3 382	5 148	8 538	11 310

APARATY GRZEWCZO-WENTYLACYJNE TYP: AS

WODNE	CENA NETTO (zł)
ASW 1/III	5 354
ASW 1/IV	5 734
ASW 2/III	6 510
ASW 2/IV	6 890
ASW 3/III	8 342
ASW 3/IV	8 981

PAROWE	CENA NETTO (zł)
ASP 1/II	5 544
ASP 1/III	5 924
ASP 2/II	6 684
ASP 2/III	7 065
ASP 3/II	8 791
ASP 3/III	9 187



WYMIENNIKI/GRZEJNIKI - Wkłady grzewcze do AS

MODEL: WODNE	CENA NETTO (zł)
WWb 1/III	1 236
WWb 1/IV	1 616
WWb 2/III	1 711
WWb 2/IV	2 123
WWb 3/III	2 218
WWb 3/IV	2 503
AOW 1/III	1 346
AOW 2/IV	*

MODEL: PAROWE	CENA NETTO (zł)
GPb 1/II	792
GPb 1/III	1 030
GPb 2/II	1 061
GPb 2/III	1 410
GPb 3/II	1 758
GPb 3/III	1 996
AOP 1/II	792

FILTR WLOTU: AS

WODNE	CENA NETTO (zł)
AS 1	396
AS 2	428
AS 3	491

SKRZYŃKA CZERPNA do AS

WODNE	CENA NETTO (zł)
Sc 1	380
Sc 2	444
Sc 3	602

CYKLONY: CT

WIELKOŚĆ:	WERSJA	WERSJA
	CZARNA	KWASOODPORNA
20	1 758	3 516
25	1 980	3 960
32	2 629	5 259
40	4 118	8 237
50	5 069	10 138



PODSTAWA CYKLONU ze zbiornikiem pyłów

WIELKOŚĆ CYKLONU	CENA NETTO (zł)	CENA NETTO (zł)
	PODSTAWA	ZBIORNIK PYŁÓW
PC 20	2 693	2 218
PC 25	2 693	2 218
PC 31,5	2 851	2 376
PC 40	2 883	2 424
PC 50	2 962	2 503

CENNIK PRODUKTÓW FUWK KONWEKTOR SP. Z O.O.

2021

APARATY GRZEWCZO-WENTYLACYJNE DO NAWIEWU PRZEWODOWEGO TYPU NP

WODNE ; PAROWE	CENA (zł)	NETTO
NPw ; NPp 1/II		10 819
NPw ; NPp 1/III		11 310
NPw ; NPp 1/IV		11 975
NPw ; NPp 2/II		12 815
NPw ; NPp 2/III		13 812
NPw ; NPp 2/IV		14 636

WODNE ; PAROWE	CENA NETTO (zł)
NPc 1/II	2 059
NPc 1/III	2 693
NPc 1/IV	3 326
NPc 2/II	3 168
NPc 2/III	4 118
NPc 2/IV	5 227

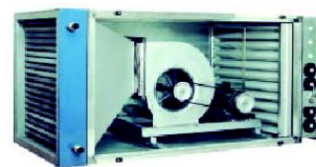

WYMIENNIK/GRZEJNIK: NPp, NPw

WODNE	CENA (zł)	NETTO
Apw 1/II		1 584
Apw 1/III		1 980
Apw 1/IV		2 439
Apw 2/II		2 344
Apw 2/III		2 899
Apw 2/IV		3 754

PAROWE	CENA NETTO (zł)
NPp 1/II	1 742
NPp 1/III	2 677
	-
NPp 2/II	2 534
NPp 2/III	3 057