

Uchylna obudowa

Silnik, wraz z przytwierdzonym do wirującego stojana wirnikiem został zabudowany na uchylnej pokrywie serwisowej, dzięki czemu dostęp w celach konserwacyjnych jest znacznie uproszczony.

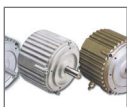

Technologia EC

Wentylatory DRB EC wyposażone zostały w nowoczesne silniki komutowane elektronicznie EC. Ich zaletą jest łatwa i płynna regulacja prędkości obrotowej w pełnym zakresie, przy jednoczesnym zachowaniu wysokiej efektywności pracy.

konstrukcja

Promieniowy wentylator kanałowy przeznaczony do instalacji kołnierzej (20 mm) w ciągu prostokątnych kanałów wentylacyjnych. Obudowa wykonana z galwanizowanej blachy stalowej, z odchyloną pokrywą serwisową, na której zawieszono moduł silnika i wirnika. Na obudowie przymocowano puszkę przyłączeniową.

wirnik

Wyważony dynamicznie wirnik typu B stanowi integralną część silnika (tzw. Silnik z wirującą obudową). Łopatkę pochyloną do tyłu wykonane z ocynkowanej galwanicznie blachy stalowej.

napęd i sterowanie

Napęd stanowi nowoczesny silnik komutowany elektronicznie EC, zasilanie jedno lub trójfazowe (230V, 400V 50 Hz) ze zintegrowanym zabezpieczeniem termicznym. Stopień ochrony silnika IP54, klasa izolacji F (B dla 60/35/3050EC). Silniki przystosowane są do płynnej regulacji prędkości obrotowej w pełnym zakresie przy zachowaniu wysokiej sprawności pracy. Sterowanie odbywa się za pomocą wbudowanego regulatora obrotów, do którego można zastosować opcjonalny potencjometr 10 kΩ lub zewnętrzny sygnał analogowy 0-10V.

maksymalna temperatura pracy

50 ÷ 60°C - w zależności od wybranego modelu.

zastosowanie

Wentylacja ogólna obiektów mieszkalnych, biurowych, przemysłowych i użyteczności publicznej.

Akcesoria



AS
wyłącznik serwisowy
str. nr 548



SENSOFLOW EC
regulator stałego ciśnienia
str. nr 545



CTP 010 / MTP10
potencjometr
str. nr 529



MTV-1/010
potencjometr
str. nr 529



VS
złącze przeciwdrganiewe
str. nr 103



VKK
żałuzja grawitacyjna
str. nr 103

tablica doboru akcesoriów dla danego wentylatora DRB EC

Typ DRB EC	30/15/700EC	40/20/1000EC	40/20/1300EC	50/25/2000EC	60/30/2950EC	60/30/3950EC
wyłącznik serwisowy	AS16A4P	AS16A4P	AS16A4P	AS16A4P	AS16A4P	AS16A4P
potencjometr	CTP 010/MTP 10/MTV-1/010	CTP 010/MTP 10/MTV-1/010	CTP 010/MTP 10/MTV-1/010	CTP 010/MTP 10/MTV-1/010	CTP 010/MTP 10/MTV-1/010	CTP 010/MTP 10/MTV-1/010
regulator stałego ciśnienia	SENSOFLOW EC	SENSOFLOW EC	SENSOFLOW EC	SENSOFLOW EC	SENSOFLOW EC	SENSOFLOW EC
złącze przeciwdrganiewe	VS 3015	VS 4020	VS 4020	VS 5025	VS 06030	VS 06030
żałuzja grawitacyjna	VKK 3015	VKK 4020	VKK 4020	VKK 5025	VKK 06030	VKK 06030

Typ DRB EC	60/35/3050EC	60/35/4600EC	70/40/5100EC	80/50/9500TEC	100/50/12400TEC
wyłącznik serwisowy	AS16A4P	AS16A4P	AS16A4P	AS16A4P	AS16A4P
potencjometr	CTP 010/MTP 10/MTV-1/010	CTP 010/MTP 10/MTV-1/010	CTP 010/MTP 10/MTV-1/010	CTP 010/MTP 10/MTV-1/010	CTP 010/MTP 10/MTV-1/010
regulator stałego ciśnienia	SENSOFLOW EC	SENSOFLOW EC	SENSOFLOW EC	SENSOFLOW EC	SENSOFLOW EC
złącze przeciwdrganiewe	VS 6035	VS 6035	VS 7040	VS 8050	VS 10050
żałuzja grawitacyjna	VKK 6035	VKK 6035	VKK 7040	VKK 8050	VKK 10050

dane techniczne

Nazwa podtyp	\dot{V}_{max} [m ³ /h]	Δp_{max} [Pa]	P_{max} [W]	U [V]	I_{max} [A]	RPM_{max} [1/min]	T_{Mmax} / T_{Amax}^* [°C]	L_{WA} [dB(A)]	L_{pA} [dB(A)]	m [kg]	nr katalogowy
DRB 30/15/700EC	700	830	114	230	0,9	4010	50/50	-	-	6,2	16519800
DRB 40/20/1000EC	1010	600	121	230	1,0	2940	60/60	61	54	9,3	13204900
DRB 40/20/1300EC	1325	670	169	230	1,4	2795	50/50	64	57	9,1	15835000
DRB 50/25/2000EC	2010	860	268	230	1,9	2930	55/55	69	62	13,8	13134500
DRB 60/30/2950EC	2930	490	167	230	1,5	1550	60/60	58	51	22,0	15656700
DRB 60/30/3950EC	3940	890	537	230	2,5	1900	50/50	69	62	24,5	15668300
DRB 60/35/3050EC	3065	475	165	230	1,4	1560	60/60	56	49	22,7	13135700
DRB 60/35/4600EC	4610	885	509	230	2,4	1920	50/50	65	58	25,1	13136100
DRB 70/40/5100EC	5170	690	510	230	2,4	1510	50/50	64	57	33,0	13136500
DRB 80/50/9500TEC	9550	1160	1328	400	2,1	1600	50/50	67	60	58,1	13137000
DRB 100/50/12400TEC	14960	1380	3490	400	5,3	1790	60/60	81	74	65,5	13137300

* T_{Mmax} - maksymalna temperatura medium / T_{Amax} - maksymalna temperatura otoczenia

wymiary

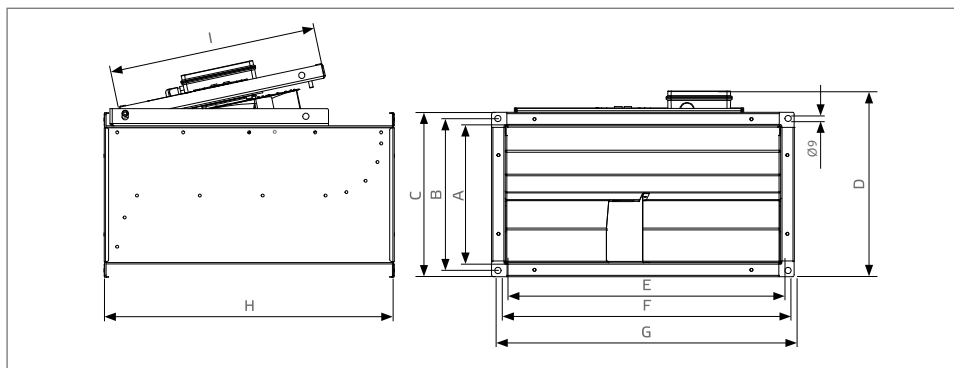

Typ DRB EC	A [mm]	B [mm]	C [mm]	D [mm]	E [mm]	F [mm]	G [mm]	H [mm]	I [mm]
DRB 30/15/700EC	150	170	188	219	300	320	338	340	239
DRB 40/20/1000EC	200	220	238	269	400	420	438	420	302
DRB 40/20/1300EC	200	220	238	269	400	420	438	420	302
DRB 50/25/2000EC	248	270	319	319	500	520	538	500	374
DRB 60/30/2950EC	300	320	338	369	600	620	638	610	485
DRB 60/30/3950EC	300	320	338	371	600	620	638	610	509
DRB 60/35/3050EC	350	370	388	419	600	620	638	610	485
DRB 60/35/4600EC	350	370	388	421	600	620	638	610	485
DRB 70/40/5100EC	400	420	438	471	700	720	738	710	550
DRB 80/50/9500TEC	500	520	538	594	800	820	838	830	644
DRB 100/50/12400TEC	500	520	538	605	1000	1020	1038	830	644

schematy elektryczne

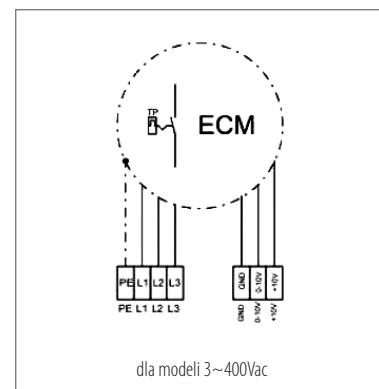
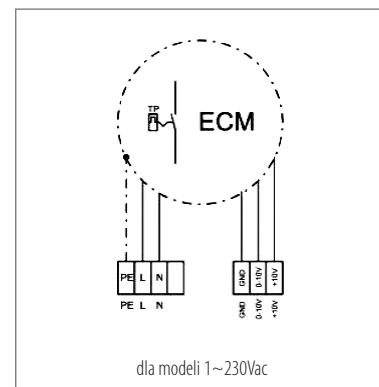

charakterystyki pracy

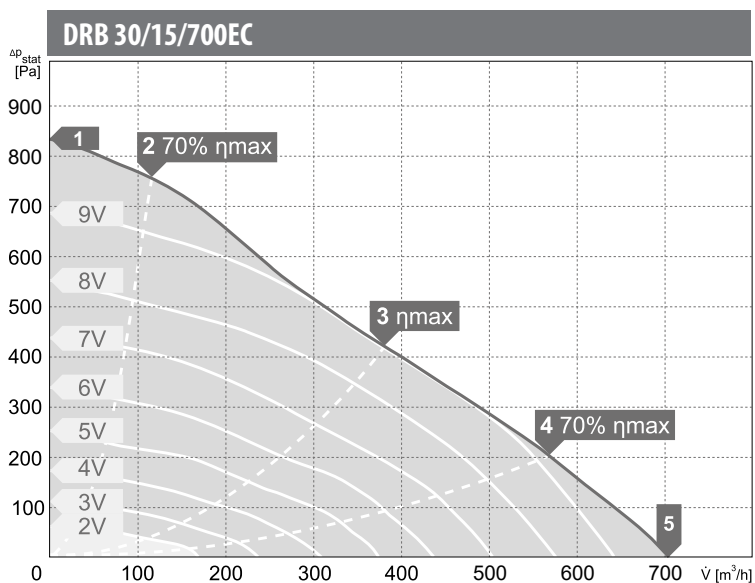

charakterystyki pracy

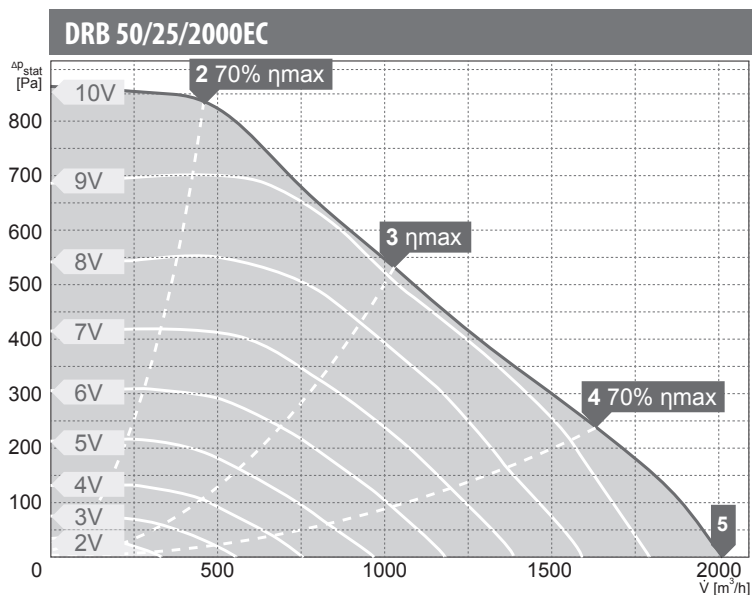
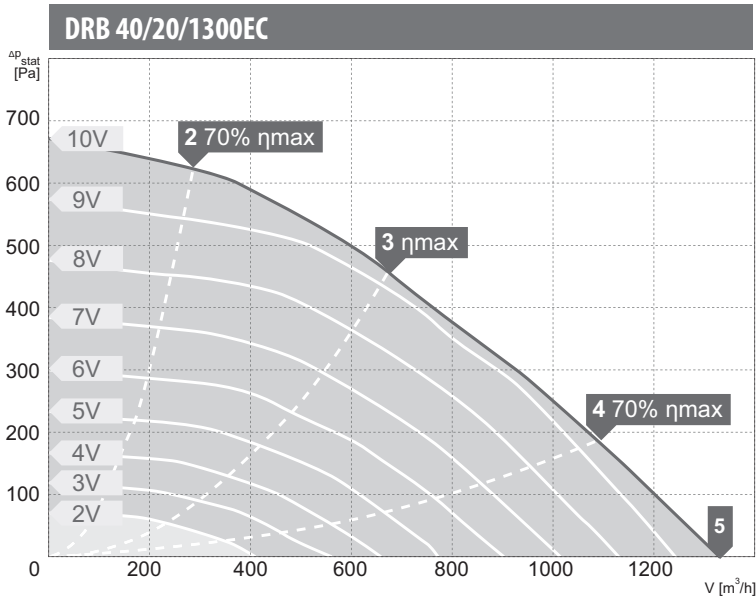
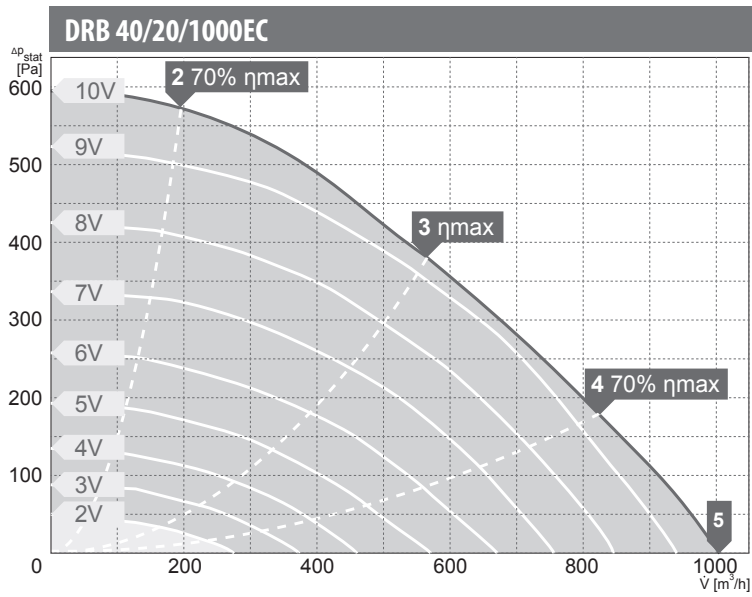

wartości mocy akustycznej L_{WA} [dB(A)]
dla poszczególnych częstotliwości pasm oktaowych [Hz]

Pkt. Pracy	Częstotliwości pasm oktaowych [Hz]								
	tot	63	125	250	500	1000	2000	4000	8000
L_{WA} wlot [dB(A)]									
2	74	41	63	69	62	68	65	61	53
3	73	37	53	69	61	66	63	60	52
4	75	39	54	71	64	68	66	64	59
5	77	45	57	72	67	71	69	66	63
L_{WA} wylot [dB(A)]									
2	77	41	61	69	70	71	73	65	55
3	76	37	53	69	69	69	71	64	55
4	78	37	52	71	71	71	73	68	61
5	81	43	55	72	74	74	76	71	66
L_{WA} od obudowy [dB(A)]									
2	62	40	50	60	55	51	50	44	40
3	61	35	44	60	55	49	48	42	36
4	62	38	46	60	56	51	50	45	38
5	66	40	48	64	59	54	53	47	42

Pkt. Pracy	Częstotliwości pasm oktaowych [Hz]								
	tot	63	125	250	500	1000	2000	4000	8000
L_{WA} wlot [dB(A)]									
2	74	42	61	72	63	65	63	60	54
3	74	39	56	72	63	65	63	60	54
4	79	41	58	78	68	71	67	65	59
5	87	44	62	86	73	75	71	69	63
L_{WA} wylot [dB(A)]									
2	76	42	60	69	70	69	70	64	57
3	76	38	57	70	70	68	69	64	57
4	82	40	57	77	76	74	74	70	61
5	86	43	60	83	78	78	78	73	66
L_{WA} od obudowy [dB(A)]									
2	65	40	52	63	57	50	50	48	44
3	64	36	46	63	55	48	48	46	41
4	68	39	47	68	59	51	49	44	37
5	74	43	50	74	62	55	52	47	42

Pkt. Pracy	Częstotliwości pasm oktaowych [Hz]								
	tot	63	125	250	500	1000	2000	4000	8000
L_{WA} wlot [dB(A)]									
2	84	47	64	74	70	76	76	80	77
3	82	41	56	76	70	74	73	76	74
4	84	39	59	80	76	77	73	74	74
5	88	43	63	84	79	82	78	77	75
L_{WA} wylot [dB(A)]									
2	84	48	67	75	77	77	76	76	74
3	83	38	56	76	77	74	75	74	73
4	88	44	61	82	83	81	81	77	75
5	92	49	63	86	85	84	84	79	76
L_{WA} od obudowy [dB(A)]									
2	73	50	56	67	60	70	62	62	55
3	69	41	47	67	59	64	56	54	52
4	78	44	51	74	65	73	59	56	53
5	79	50	54	77	69	74	62	59	54

charakterystyki pracy

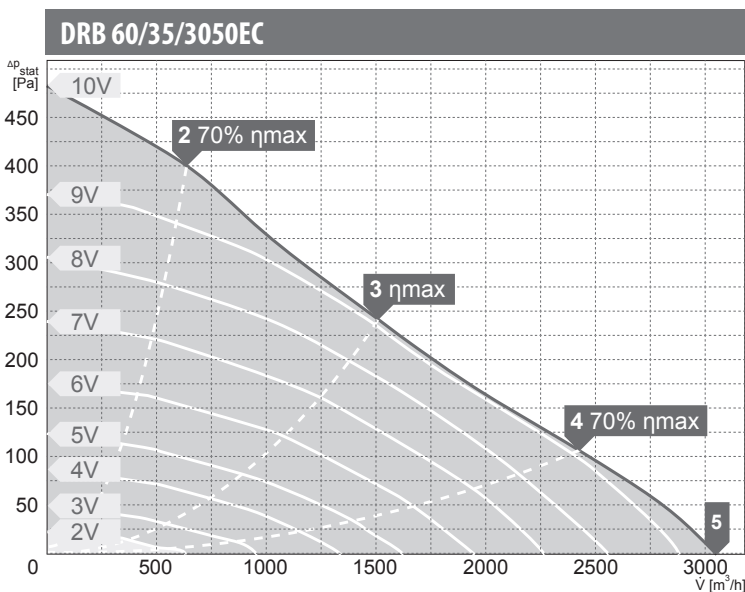
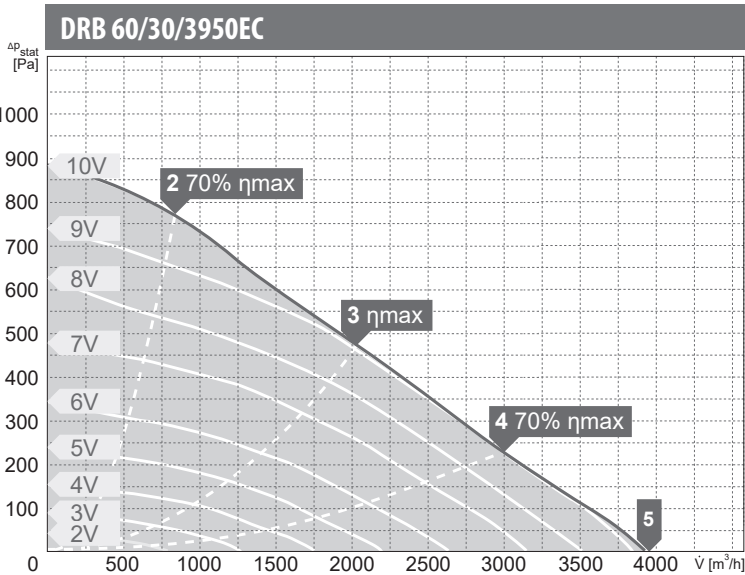
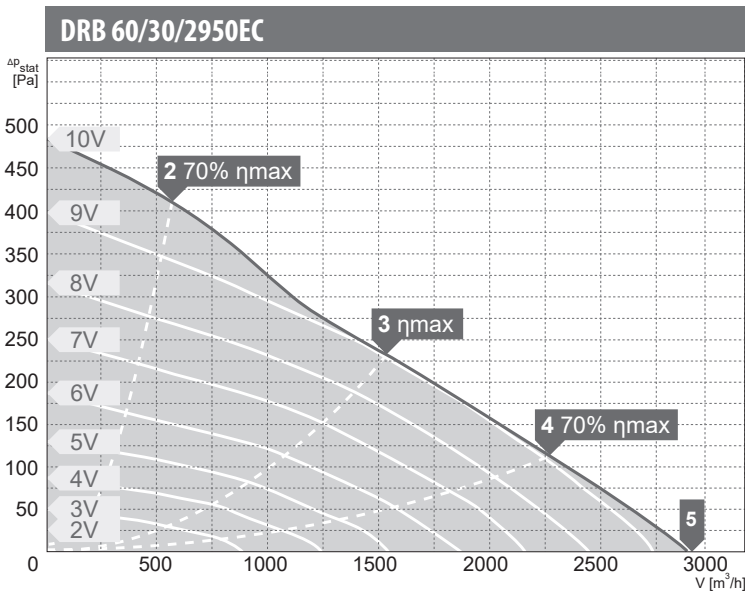

wartości mocy akustycznej L_{WA} [dB(A)]
dla poszczególnych częstotliwości pasm oktawowych [Hz]

Pkt. Pracy	Częstotliwości pasm oktawowych [Hz]								
	tot	63	125	250	500	1000	2000	4000	8000
L_{WA} wlot [dB(A)]									
2	66	43	61	61	57	59	55	49	42
3	65	34	59	60	57	57	53	48	39
4	72	40	65	67	64	64	60	56	52
5	76	45	69	71	69	69	65	61	61
L_{WA} wylot [dB(A)]									
2	71	47	64	63	65	67	61	56	47
3	68	36	61	61	62	63	57	52	42
4	75	41	66	68	69	70	64	60	58
5	81	45	73	73	75	75	70	65	65
L_{WA} od obudowy [dB(A)]									
2	60	47	55	54	49	50	50	49	39
3	58	35	55	52	46	46	46	41	28
4	61	42	58	57	51	48	44	36	33
5	67	48	64	62	58	55	50	44	42

Pkt. Pracy	Częstotliwości pasm oktawowych [Hz]								
	tot	63	125	250	500	1000	2000	4000	8000
L_{WA} wlot [dB(A)]									
2	77	53	70	72	69	72	67	63	56
3	79	44	75	72	70	71	65	61	54
4	83	49	79	77	76	76	70	65	58
5	86	53	76	80	80	81	75	70	63
L_{WA} wylot [dB(A)]									
2	84	58	76	75	76	79	75	69	61
3	84	50	80	76	75	76	71	64	57
4	88	54	84	80	81	82	76	68	61
5	92	58	80	84	86	87	82	74	67
L_{WA} od obudowy [dB(A)]									
2	71	55	66	65	58	62	63	55	47
3	69	48	64	64	57	62	62	51	43
4	73	52	69	68	62	65	61	48	39
5	81	55	80	73	68	68	60	54	47

Pkt. Pracy	Częstotliwości pasm oktawowych [Hz]								
	tot	63	125	250	500	1000	2000	4000	8000
L_{WA} wlot [dB(A)]									
2	66	45	62	60	58	58	55	49	40
3	66	33	65	58	56	55	52	47	38
4	72	40	69	64	62	61	59	56	54
5	77	45	73	69	67	67	65	62	62
L_{WA} wylot [dB(A)]									
2	71	48	64	63	64	66	60	54	45
3	70	34	67	61	62	62	55	51	43
4	75	38	70	66	68	68	63	60	58
5	81	42	77	71	73	73	69	66	66
L_{WA} od obudowy [dB(A)]									
2	60	49	57	52	49	49	45	40	31
3	56	35	54	48	45	45	40	32	23
4	62	40	60	55	51	50	44	36	35
5	67	45	65	60	57	56	50	42	42

charakterystyki pracy

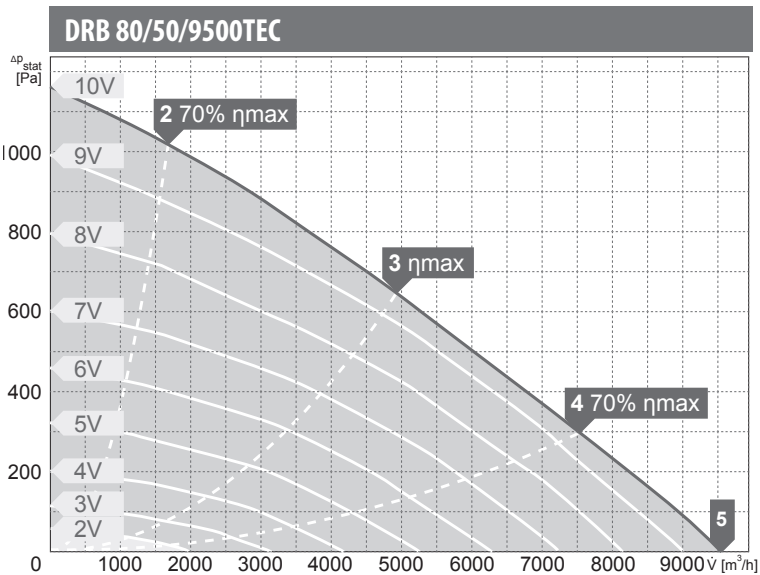
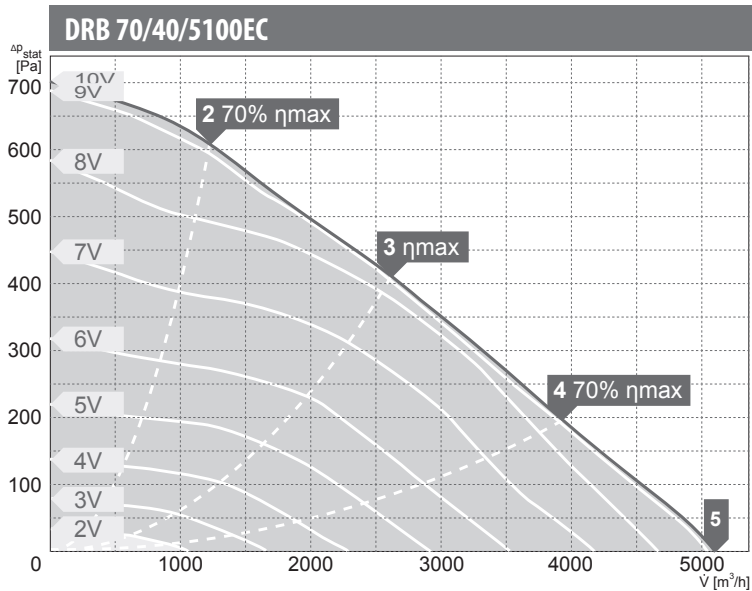
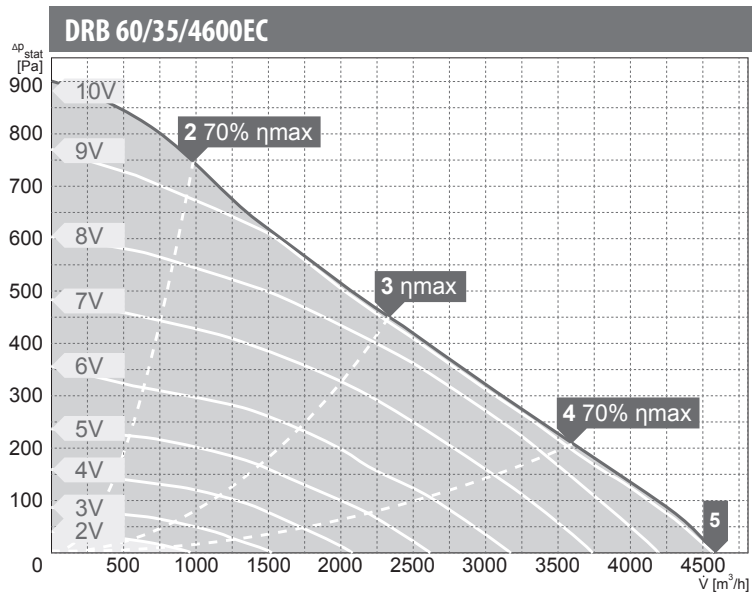

wartości mocy akustycznej L_{WA} [dB(A)]
dla poszczególnych częstotliwości pasm oktaowych [Hz]

Pkt.	Pracy	Częstotliwości pasm oktaowych [Hz]							
		tot	63	125	250	500	1000	2000	4000
L_{WA} wlot [dB(A)]									
2	79	56	74	72	69	70	68	64	56
3	78	44	76	67	67	67	64	61	55
4	82	50	79	74	74	73	70	65	61
5	85	54	80	78	78	78	75	69	67
L_{WA} wylot [dB(A)]									
2	84	58	78	75	75	78	74	68	60
3	79	44	76	70	71	72	67	64	56
4	85	48	79	76	78	79	73	67	62
5	90	54	83	80	83	84	79	73	70
L_{WA} od obudowy [dB(A)]									
2	70	56	67	64	58	58	55	49	42
3	65	44	64	57	52	53	49	45	37
4	71	49	69	64	59	59	53	46	40
5	74	55	70	69	66	65	59	52	46

Pkt.	Pracy	Częstotliwości pasm oktaowych [Hz]							
		tot	63	125	250	500	1000	2000	4000
L_{WA} wlot [dB(A)]									
2	78	55	69	67	72	71	71	64	56
3	75	47	66	64	69	68	68	64	56
4	79	53	71	70	74	71	69	66	61
5	84	55	76	74	78	76	75	69	68
L_{WA} wylot [dB(A)]									
2	84	58	71	73	78	80	77	70	61
3	81	51	72	71	75	76	73	68	59
4	84	53	75	75	78	79	74	70	63
5	89	56	80	80	83	85	80	73	70
L_{WA} od obudowy [dB(A)]									
2	68	56	65	60	59	57	53	45	36
3	64	47	63	56	55	53	49	44	35
4	69	51	67	62	60	58	51	46	39
5	73	55	70	66	65	63	58	50	46

Pkt.	Pracy	Częstotliwości pasm oktaowych [Hz]							
		tot	63	125	250	500	1000	2000	4000
L_{WA} wlot [dB(A)]									
2	79	63	72	66	72	72	71	68	62
3	81	49	79	67	71	71	69	66	60
4	84	54	80	72	76	76	75	71	66
5	87	58	81	76	79	81	79	75	70
L_{WA} wylot [dB(A)]									
2	85	61	75	76	79	79	76	72	65
3	83	50	75	76	78	77	73	69	63
4	90	55	81	81	84	84	80	75	68
5	95	60	85	86	89	89	85	80	73
L_{WA} od obudowy [dB(A)]									
2	72	61	69	63	62	61	59	57	51
3	67	50	64	60	60	58	55	52	46
4	72	55	68	66	65	63	60	56	47
5	77	61	72	71	70	68	65	61	52

charakterystyki pracy

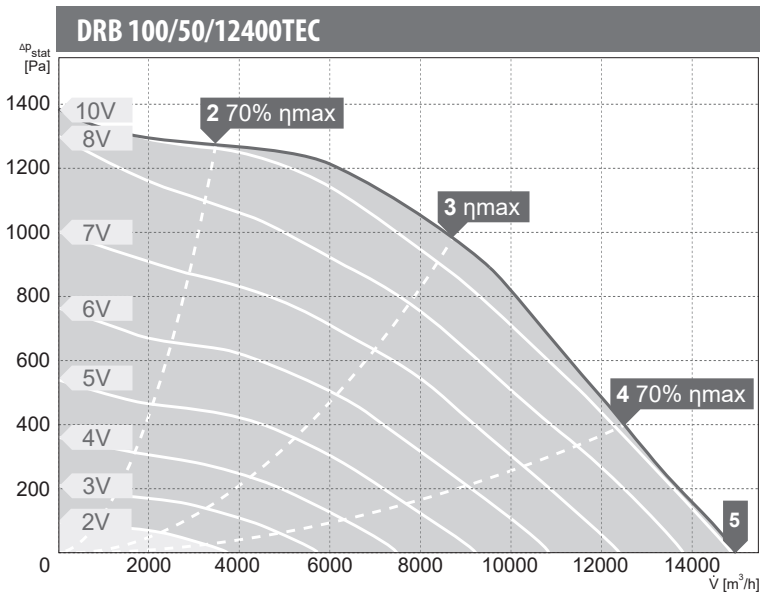

wartości mocy akustycznej L_{WA} [dB(A)]
dla poszczególnych częstotliwości pasm oktaowych [Hz]

Pkt.	Pracy	Częstotliwości pasm oktaowych [Hz]							
		tot	63	125	250	500	1000	2000	4000
L_{WA} wlot [dB(A)]									
2	88	69	81	79	82	82	80	75	68
3	89	57	83	83	83	81	79	77	73
4	94	63	85	86	88	86	83	80	83
5	95	64	86	87	90	88	85	82	85
L_{WA} wylot [dB(A)]									
2	94	66	83	86	88	89	85	79	70
3	94	57	87	88	87	88	84	81	76
4	99	61	88	92	93	93	89	84	86
5	100	62	89	93	93	95	90	86	88
L_{WA} od obudowy [dB(A)]									
2	80	63	75	72	72	72	70	63	53
3	81	54	78	76	71	72	69	64	56
4	84	60	79	78	76	75	72	66	64
5	84	61	80	79	77	75	73	66	65