

Izolacja akustyczna

Izolację stanowi warstwa 30 mm wysokiej jakości wełny kamiennej o gęstości 88 kg/m³, która znacznie lepiej absorbuje dźwięki o niskiej częstotliwości. Izolacja spełnia wymogi przeciwpożarowe dla klasy A2 – niepalnej.

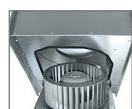

Uchylna obudowa

Silnik, wraz z przytwierdzonym do wirującego stojana wirnikiem został zabudowany na uchylniej pokrywie serwisowej, dzięki czemu dostęp w celach konserwacyjnych jest znacznie uproszczony.

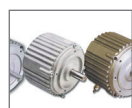

Technologia EC

Wentylatory DRBI EC wyposażone zostały w nowoczesne silniki komutowane elektronicznie EC. Ich zaletą jest łatwa i płynna regulacja prędkości obrotowej w pełnym zakresie, przy jednoczesnym zachowaniu wysokiej efektywności pracy.

konstrukcja

Promieniowy wentylator kanałowy przeznaczony do instalacji kołnierzej (20mm) w ciągu prostokątnych kanałów wentylacyjnych. Izolowana obudowa wykonana z galwanizowanej blachy stalowej, z odchylną pokrywą serwisową, na której zawieszono moduł silnika i wirnika.

wirnik

Wyważany dynamicznie wirnik typu B stanowi integralną część silnika (tzw. Silnik z wirującą obudową). Łopatki pochylone do tyłu wykonane z ocynkowanej galwanicznie blachy stalowej.

napęd i sterowanie

Napęd stanowi nowoczesny silnik komutowany elektronicznie EC, zasilanie jedno lub trójfazowe (230V, 400V 50 Hz) ze zintegrowanym czujnikiem temperatury uzwojeń. Stopień ochrony silnika IP54, klasa izolacji F (B dla DRBI 60/35/2800EC). Silniki przystosowane są do płynnej regulacji prędkości obrotowej w pełnym zakresie przy zachowaniu wysokiej sprawności pracy. Sterowanie odbywa się za pomocą wbudowanego regulatora obrotów, do którego można zastosować opcjonalny potencjometr 10 kΩ lub zewnętrzny sygnał analogowy 0-10V.

maksymalna temperatura pracy

50 ± 60°C - w zależności od wybranego modelu.

zastosowanie

Wentylacja ogólna obiektów mieszkalnych, biurowych, przemysłowych i użyteczności publicznej.

Akcesoria



AS
wyłącznik serwisowy
str. nr 548



SENSOFLOW EC
regulator stałego ciśnienia
str. nr 545



CTP 010/MTP 10
potencjometr
str. nr 529



MTV-1/010
potencjometr
str. nr 529



VS
złącze przeciwdrganiewe
str. nr 103



VKK
żaluzja grawitacyjna
str. nr 103

tablica doboru akcesoriów dla danego wentylatora DRBI EC

Typ DRBI EC	30/15/700EC	40/20/1450EC	50/25/1750EC	60/30/2400EC	60/30/3350EC
wyłącznik serwisowy	AS16A4P	AS16A4P	AS16A4P	AS16A4P	AS16A4P
potencjometr	CTP 010/MTP 10/MTV-1/010	CTP 010/MTP 10/MTV-1/010	CTP 010/MTP 10/MTV-1/010	CTP 010/MTP 10/MTV-1/010	CTP 010/MTP 10/MTV-1/010
regulator stałego ciśnienia	SENSOFLOW EC	SENSOFLOW EC	SENSOFLOW EC	SENSOFLOW EC	SENSOFLOW EC
złącze przeciwdrganiewe	VS 03015	VS 04020	VS 5025	VS 06030	VS 06030
żaluzja grawitacyjna	VKK 03015	VKK 04020	VKK 5025	VKK 06030	VKK 06030

Typ DRBI EC	60/35/2800EC	60/35/4300EC	70/40/4900EC	80/50/8500TEC	100/50/11500TEC
wyłącznik serwisowy	AS16A4P	AS16A4P	AS16A4P	AS16A4P	AS16A4P
potencjometr	CTP 010/MTP 10/MTV-1/010	CTP 010/MTP 10/MTV-1/010	CTP 010/MTP 10/MTV-1/010	CTP 010/MTP 10/MTV-1/010	CTP 010/MTP 10/MTV-1/010
regulator stałego ciśnienia	SENSOFLOW EC	SENSOFLOW EC	SENSOFLOW EC	SENSOFLOW EC	SENSOFLOW EC
złącze przeciwdrganiewe	VS 6035	VS 6035	VS 7040	VS 8050	VS 10050
żaluzja grawitacyjna	VKK 6035	VKK 6035	VKK 7040	VKK 8050	VKK 10050

dane techniczne

Nazwa podtyp	\dot{V}_{max} [m ³ /h]	Δp_{max} [Pa]	P_{max} [W]	U [V]	I_{max} [A]	RPM _{max} [1/min]	T_{Mmax}/T_{Amax}^* [°C]	L_{WA} [dB(A)]	L_{pA} [dB(A)]	nr katalogowy
DRBI 30/15/700EC	690	660	107	230	0,9	3580	60	59	52	15658500
DRBI 40/20/1450EC	1330	650	172	230	1,5	2760	50	63	56	15929100
DRBI 50/25/1750EC	1790	860	268	230	1,9	2960	55/55	63	56	13143400
DRBI 60/30/2400EC	2410	460	165	230	1,5	1530	60	57	50	15681200
DRBI 60/30/3350EC	3330	880	531	230	2,5	1900	60	66	59	15684100
DRBI 60/35/2800EC	2845	465	164	230	1,4	1540	60/60	52	45	13143700
DRBI 60/35/4300EC	4390	890	523	230	2,4	1910	50/50	59	52	13144000
DRBI 70/40/4900EC	4950	660	523	230	2,4	1510	50/50	59	52	13143100
DRBI 80/50/8500TEC	8570	1180	1173	400	1,8	1620	50/50	62	55	13144300
DRBI 100/50/11500TEC	14830	1380	3455	400	5,3	1800	60/60	78	71	13144600

wymiary

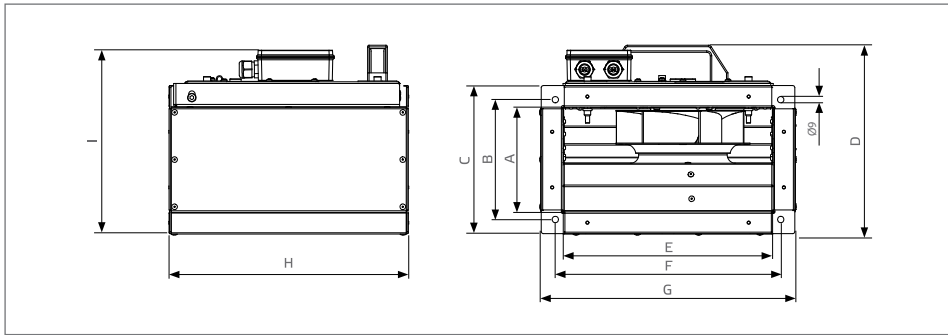

wymiary

Typ DRBI EC	A [mm]	B [mm]	C [mm]	D [mm]	E [mm]	F [mm]	G [mm]	H [mm]	I [mm]
DRBI 30/15/700EC	150	170±1	218	268±2	300	320±1	362	340	261
DRBI 40/20/1450EC	200	220±1	266	318±2	400	420±1	462	420	311
DRBI 50/25/1750EC	250	270	311	368	500	520	562	500	361
DRBI 60/30/2400EC	300	320	366	419	600	620	662	610	412
DRBI 60/30/3350EC	300	320	366	419	600	620	662	610	412
DRBI 60/35/2800EC	350	370	411	469	600	620	662	610	-
DRBI 60/35/4300EC	350	370	411	469	600	620	662	610	462
DRBI 70/40/4900EC	400	420	461	519	700	720	762	710	512
DRBI 80/50/8500TEC	500	520	561	619	800	820	862	830	611
DRBI 100/50/11500TEC	500	520	561	619	1000	1020	1062	830	629

schematy elektryczne

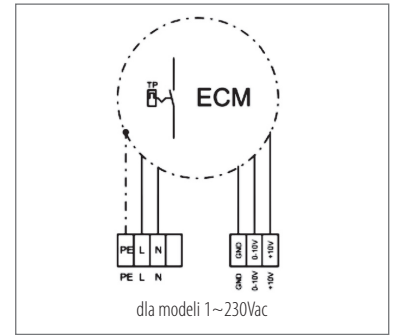

schematy elektryczne

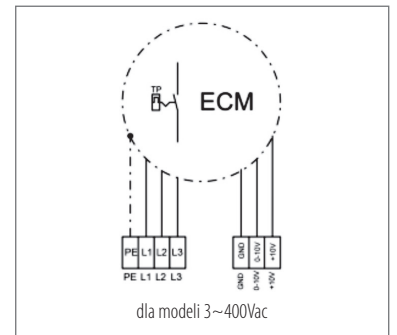

charakterystyki pracy

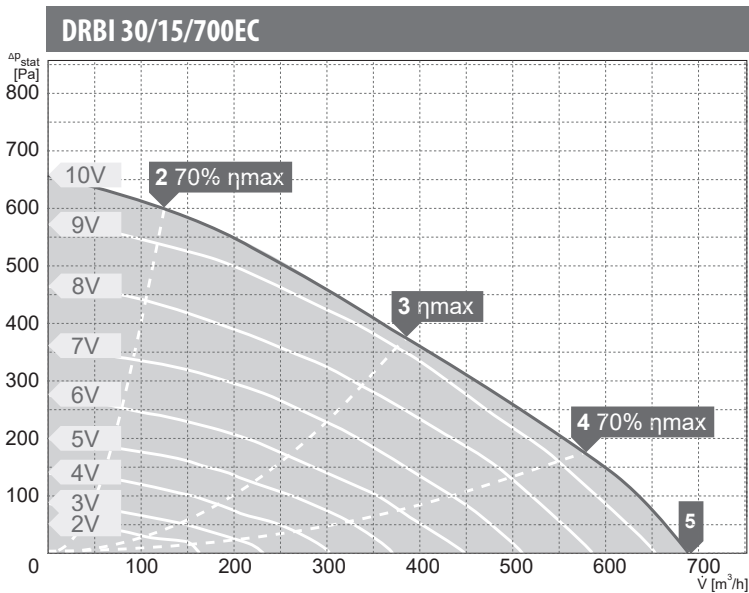

wartości mocy akustycznej L_{WA} [dB(A)]
dla poszczególnych częstotliwości pasm oktaowych [Hz]

Pkt. Pracy	tot	Częstotliwości pasm oktaowych [Hz]							
		63	125	250	500	1000	2000	4000	8000
L_{WA} wlot [dB(A)]									
2	67	40	55	61	65	56	54	51	48
3	66	37	53	59	64	54	52	50	46
4	68	38	54	62	65	58	56	53	50
5	70	39	55	63	66	60	59	56	53
L_{WA} wylot [dB(A)]									
2	76	39	56	69	71	69	68	64	56
3	74	39	53	65	69	68	67	62	55
4	78	37	52	66	73	71	72	68	62
5	80	39	54	68	76	74	74	70	65
L_{WA} od obudowy [dB(A)]									
2	61	41	47	55	57	54	51	49	44
3	59	41	45	51	55	52	49	50	41
4	60	36	43	52	57	54	49	42	35
5	63	40	46	54	60	56	50	43	38

charakterystyki pracy

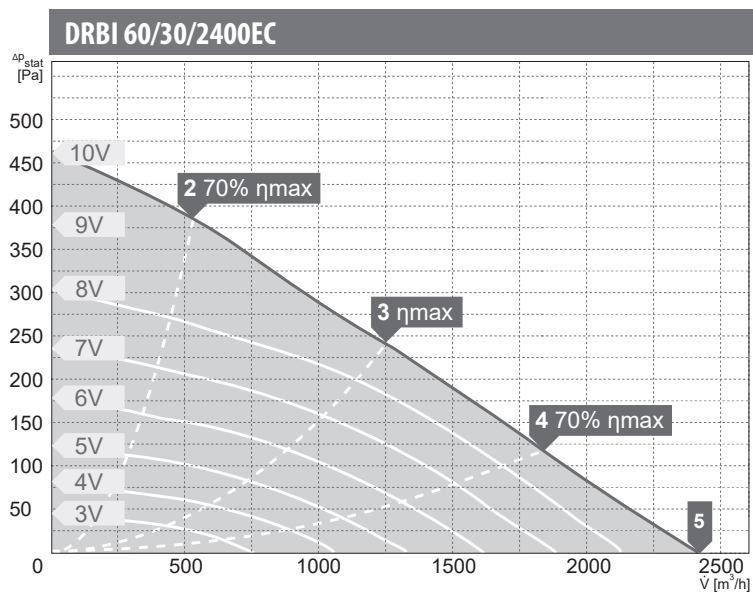
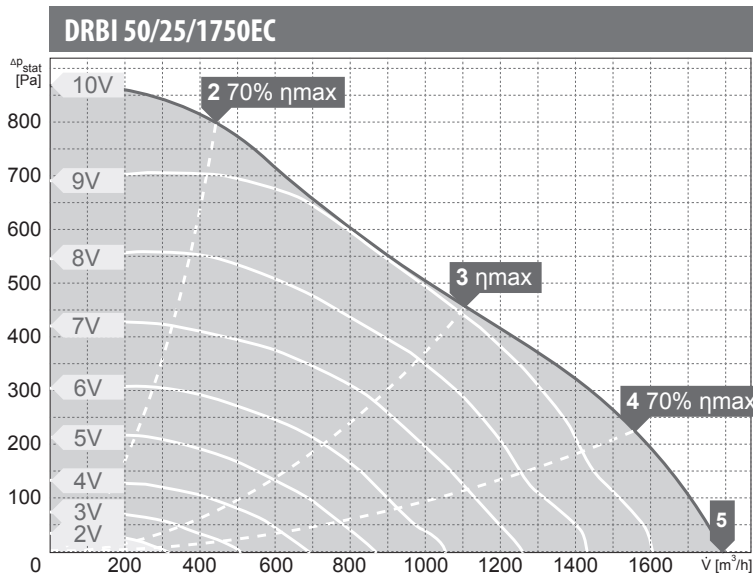
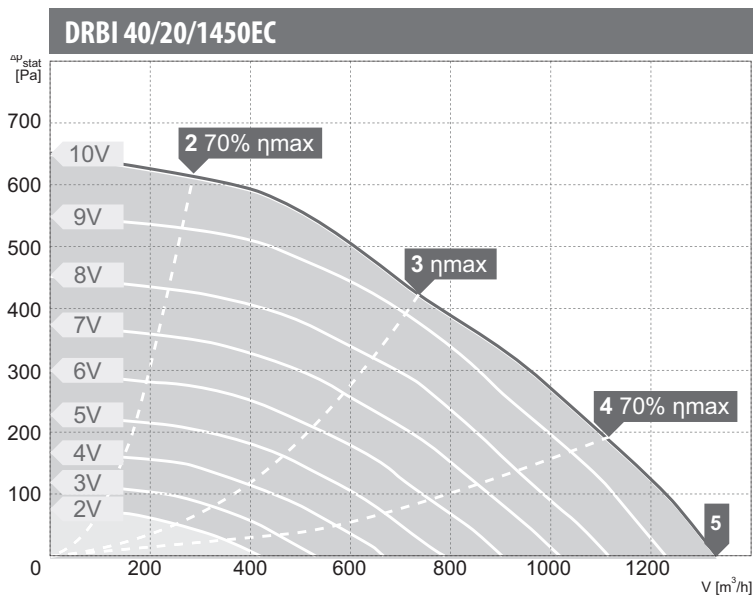

wartości mocy akustycznej L_{WA} [dB(A)]
dla poszczególnych częstotliwości pasm oktaowych [Hz]

Pkt. Pracy	tot	Częstotliwości pasm oktaowych [Hz]							
		63	125	250	500	1000	2000	4000	8000
L_{WA} wlot [dB(A)]									
2	70	43	62	67	58	57	53	54	50
3	69	40	57	67	56	56	52	52	46
4	72	40	56	71	62	59	55	55	49
5	78	44	60	77	66	64	59	59	54
L_{WA} wylot [dB(A)]									
2	75	42	65	71	69	66	67	62	59
3	74	36	56	69	68	65	66	62	55
4	79	38	57	76	72	70	71	67	60
5	86	42	60	84	76	74	75	70	64
L_{WA} od obudowy [dB(A)]									
2	65	41	52	61	58	48	49	49	45
3	63	38	44	60	60	46	46	45	40
4	66	37	45	64	61	46	44	40	35
5	69	40	49	68	59	50	47	42	37

Pkt. Pracy	tot	Częstotliwości pasm oktaowych [Hz]							
		63	125	250	500	1000	2000	4000	8000
L_{WA} wlot [dB(A)]									
2	72	47	62	68	64	62	58	60	56
3	71	40	55	67	65	62	59	60	59
4	76	47	60	72	70	68	63	63	59
5	79	51	64	75	73	71	66	65	61
L_{WA} wylot [dB(A)]									
2	79	48	62	72	72	71	72	69	67
3	80	41	57	75	73	72	73	70	68
4	85	48	63	81	78	77	77	73	69
5	88	51	64	84	82	80	80	75	71
L_{WA} od obudowy [dB(A)]									
2	67	51	56	58	53	60	61	58	47
3	63	41	50	60	54	55	55	50	44
4	68	50	56	65	59	60	53	48	43
5	70	58	60	66	62	63	53	49	44

Pkt. Pracy	tot	Częstotliwości pasm oktaowych [Hz]							
		63	125	250	500	1000	2000	4000	8000
L_{WA} wlot [dB(A)]									
2	62	46	60	54	50	47	45	44	40
3	59	38	58	51	49	45	42	39	34
4	64	43	62	56	54	49	46	44	37
5	68	47	65	61	59	54	52	52	47
L_{WA} wylot [dB(A)]									
2	69	48	63	62	61	63	57	53	45
3	65	38	60	58	57	59	53	49	40
4	71	41	66	64	63	64	56	54	47
5	75	45	69	68	68	69	62	56	58
L_{WA} od obudowy [dB(A)]									
2	60	46	54	49	50	53	54	52	44
3	57	36	52	43	45	50	49	49	38
4	57	40	55	48	46	47	43	37	28
5	61	44	60	52	49	47	37	28	35

charakterystyki pracy

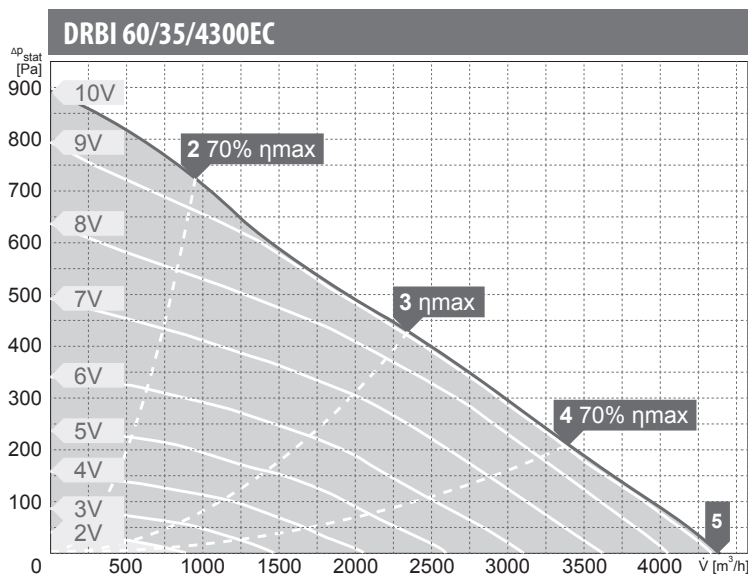
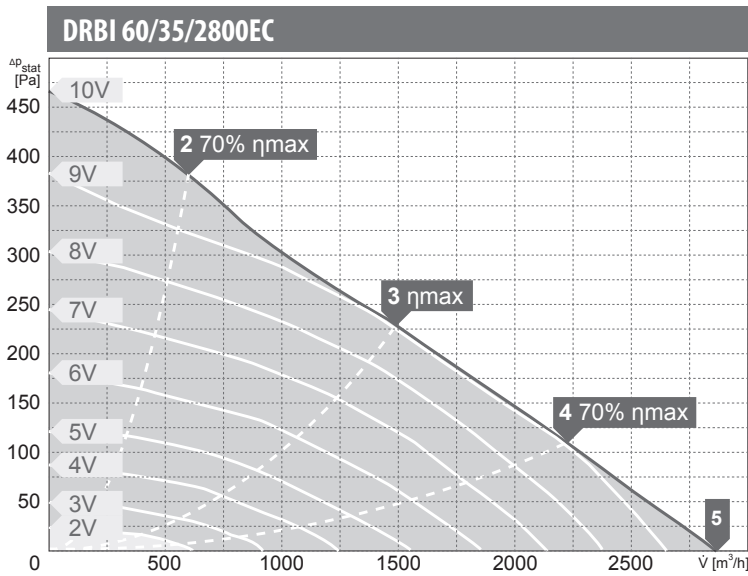
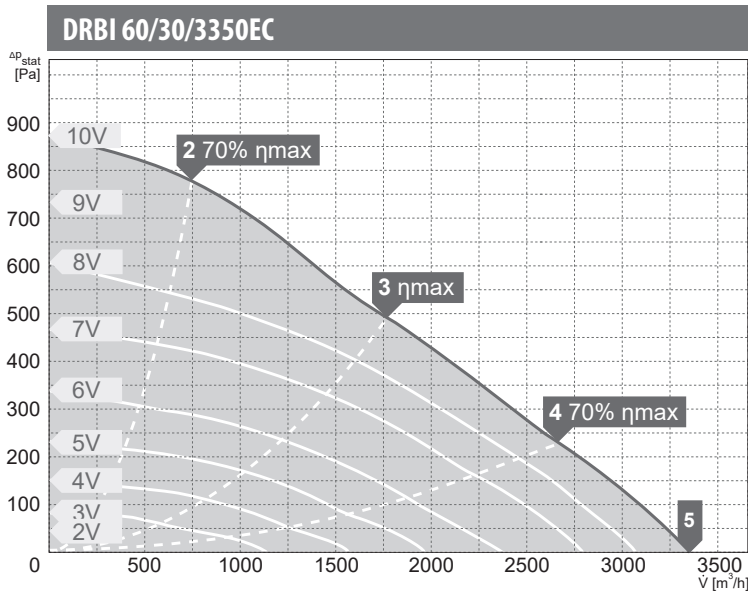

wartości mocy akustycznej L_{WA} [dB(A)]
dla poszczególnych częstotliwości pasm oktawowych [Hz]

Pkt. Pracy	Częstotliwości pasm oktawowych [Hz]								
	tot	63	125	250	500	1000	2000	4000	8000
L_{WA} wlot [dB(A)]									
2	75	54	72	69	64	58	56	57	54
3	69	50	66	62	60	55	55	55	50
4	71	47	67	64	64	58	57	60	53
5	76	51	73	69	68	63	62	66	63
L_{WA} wylot [dB(A)]									
2	82	59	76	75	74	76	72	68	62
3	78	49	71	69	70	72	68	66	60
4	80	48	73	73	73	74	69	67	61
5	84	51	77	77	77	79	73	69	66
L_{WA} od obudowy [dB(A)]									
2	70	55	65	63	57	64	62	56	49
3	66	47	60	55	54	62	54	52	45
4	67	46	62	58	57	64	53	48	37
5	69	50	66	62	59	60	52	44	39

Pkt. Pracy	Częstotliwości pasm oktawowych [Hz]								
	tot	63	125	250	500	1000	2000	4000	8000
L_{WA} wlot [dB(A)]									
2	61	49	60	53	50	45	44	42	36
3	58	36	58	46	45	41	40	35	28
4	61	41	60	52	51	46	48	43	40
5	69	45	67	57	56	51	54	50	47
L_{WA} wylot [dB(A)]									
2	68	49	61	61	61	63	57	51	44
3	64	35	59	56	56	57	51	48	39
4	68	37	62	60	60	62	55	54	51
5	73	42	65	65	66	68	62	57	60
L_{WA} od obudowy [dB(A)]									
2	56	47	54	47	43	42	43	42	35
3	52	34	51	40	37	37	36	30	23
4	55	37	54	44	40	38	34	26	24
5	59	43	58	50	45	41	36	28	33

Pkt. Pracy	Częstotliwości pasm oktawowych [Hz]								
	tot	63	125	250	500	1000	2000	4000	8000
L_{WA} wlot [dB(A)]									
2	72	56	71	64	60	55	55	52	48
3	65	43	62	58	56	51	52	49	44
4	69	46	66	62	60	55	56	57	49
5	75	50	72	66	66	60	62	64	59
L_{WA} wylot [dB(A)]									
2	80	56	75	73	73	74	69	64	56
3	74	44	69	66	66	68	63	58	51
4	78	46	72	70	71	72	66	60	57
5	82	48	75	75	75	77	71	66	62
L_{WA} od obudowy [dB(A)]									
2	65	57	63	59	51	48	50	43	38
3	59	42	58	51	46	42	41	35	28
4	61	44	59	54	49	44	42	34	30
5	66	48	64	59	54	48	45	39	35

charakterystyki pracy

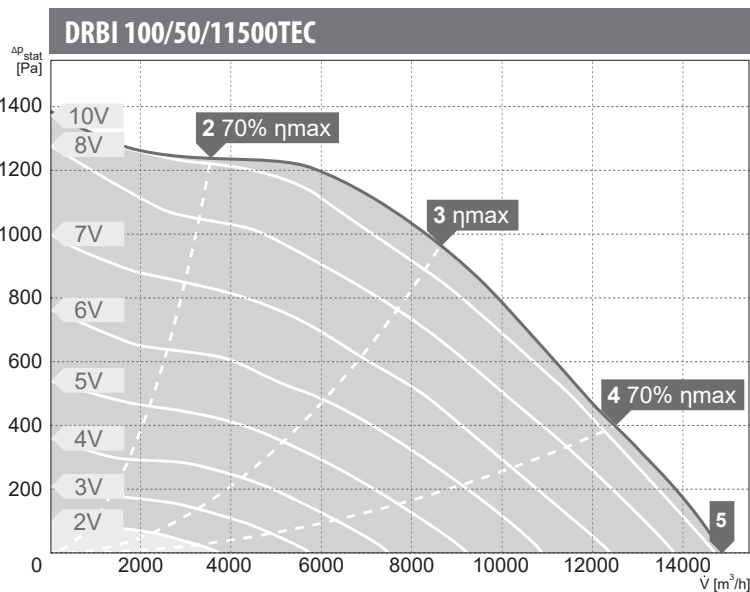
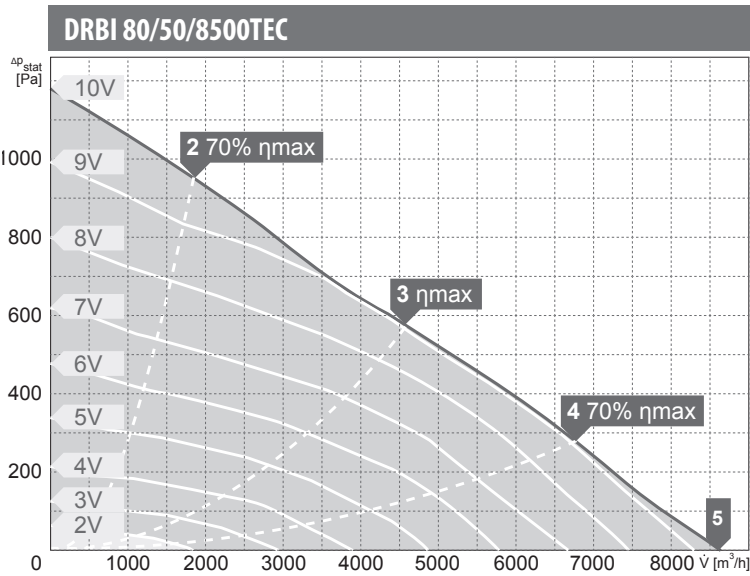
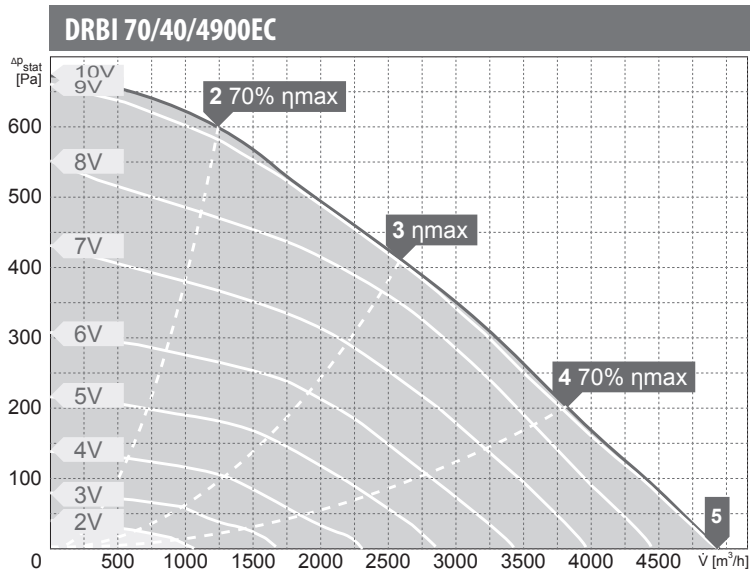

wartości mocy akustycznej L_{WA} [dB(A)]
dla poszczególnych częstotliwości pasm oktaowych [Hz]

Pkt. Pracy	tot	Częstotliwości pasm oktaowych [Hz]							
		63	125	250	500	1000	2000	4000	8000
L_{WA} wlot [dB(A)]									
2	72	56	69	62	66	58	60	53	46
3	66	45	63	57	61	54	56	49	42
4	69	49	65	61	63	56	58	54	46
5	74	52	69	65	68	61	64	61	53
L_{WA} wylot [dB(A)]									
2	81	53	70	72	75	77	73	66	57
3	77	44	68	68	70	72	69	62	54
4	79	48	70	72	72	73	68	63	57
5	83	51	74	75	77	78	74	67	61
L_{WA} od obudowy [dB(A)]									
2	65	52	63	58	55	50	49	44	39
3	59	41	57	48	50	47	46	45	42
4	65	47	63	57	53	49	45	39	32
5	67	51	66	60	57	53	50	48	40

Pkt. Pracy	tot	Częstotliwości pasm oktaowych [Hz]							
		63	125	250	500	1000	2000	4000	8000
L_{WA} wlot [dB(A)]									
2	74	59	69	64	65	62	67	66	61
3	69	49	61	60	61	60	62	60	54
4	71	52	63	64	64	63	64	63	55
5	77	56	66	68	68	67	69	69	62
L_{WA} wylot [dB(A)]									
2	82	60	74	75	77	76	72	69	62
3	77	47	67	70	72	71	68	64	58
4	82	51	69	73	77	76	74	69	64
5	87	55	72	78	81	81	78	74	68
L_{WA} od obudowy [dB(A)]									
2	69	57	65	59	57	56	59	58	50
3	62	45	58	53	52	51	55	53	44
4	63	48	59	57	56	52	51	47	37
5	68	53	63	62	61	57	55	49	39

Pkt. Pracy	tot	Częstotliwości pasm oktaowych [Hz]							
		63	125	250	500	1000	2000	4000	8000
L_{WA} wlot [dB(A)]									
2	81	62	76	75	76	69	67	64	61
3	84	57	79	79	79	70	67	66	63
4	87	62	80	82	83	74	71	68	70
5	89	64	82	83	84	76	73	71	72
L_{WA} wylot [dB(A)]									
2	91	70	83	85	86	85	81	75	67
3	92	58	86	86	85	84	80	77	73
4	96	63	87	89	90	90	84	80	80
5	97	63	89	90	90	90	85	81	82
L_{WA} od obudowy [dB(A)]									
2	78	65	74	69	69	71	69	64	55
3	78	53	73	71	69	71	68	64	55
4	78	59	72	72	71	71	69	61	56
5	80	59	75	74	72	72	70	62	57