

ML PRO EC

wentylatory kanałowe

Element systemu
SENSOVENT



ML PRO 150-200 EC

ML PRO 250-355 EC

TECHNOLOGIA EC



Wentylatory ML PRO EC wyposażone zostały w nowoczesne silniki komutowane elektronicznie (EC). Ich niewątpliwą zaletą jest: niski pobór energii, płynna i precyzyjna regulacja prędkości obrotowej w pełnym zakresie przy zachowaniu wysokiej efektywności, miękki start, cicha praca.

konstrukcja

Diagonalny wentylator kanałowy. Obudowa wykonana została z wysokiej jakości tworzywa PPGF30 (polipropylen z dodatkiem 30% włókna szklanego, kolor RAL7012). Unikalny wyprofilowany wirnik diagonalny z tworzywa sztucznego został wyważony dynamicznie w dwóch płaszczyznach (G6.3 DIN ISO 1940). Urządzenie składa się z trzech elementów: płyty montażowej, zespołu silnikowo-wirnika ze zintegrowaną puszką przyłączeniową, oraz króćców przyłączeniowych. Całość połączona została za pomocą dwóch uchylnych klamer. Wentylator można zainstalować w dowolnej pozycji. Dostęp do modułu silnika nie wymaga demontażu kanałów wentylacyjnych.

napęd i sterowanie

Napęd stanowi silnik elektryczny komutowany elektronicznie (EC) ze zintegrowanym kontrolerem i zabezpieczeniem termicznym. Zasilanie 230V ~1, 50Hz. Silniki przystosowane są do płynnej regulacji prędkości obrotowej w pełnym zakresie przy zachowaniu wysokiej sprawności. Zmiana prędkości obrotowej odbywa się poprzez podłączenie potencjometru lub innego urządzenia (sterownika) wykorzystującego sygnał analogowy 0-10V. W zestawie potencjometr do samodzielnego podłączenia w puszcze przyłączeniowej. Stopień ochrony urządzenia IPX4, puszkę przyłączeniową IP44. Klasa izolacji F.

maksymalna temperatura pracy

35 ÷ 45°C w zależności od modelu.

zastosowanie

Transport czystego, niezapylonego powietrza w instalacjach wentylacyjnych do i z pomieszczeń w obiektach: mieszkalnych, biurowych, przemysłowych i użyteczności publicznej.



diagonalny wirnik
do 50% lepsza sprawność

demontowalne króćce
prosty montaż

Akcesoria



GS
wyłącznik serwisowy
str. nr 548



CON P-1000
regulator stałego ciśnienia
str. nr 545



MTP 10 / MTV-010
potencjometr
str. nr 529



OFK
klamra montażowa
str. nr 94



SDS
tłumik kanałowy prosty
str. nr 97



FLEXITEC
tłumik kanałowy elastyczny
str. nr 96



SG
siatka ochronna
str. nr 97



RSK
klapa zwrotna
str. nr 94



FBM
filtr kanałowy EU3
str. nr 93



FBB
kasetka filtra kieszeniowego
str. nr 93

Tablica doboru akcesoriów dla danego wentylatora ML PRO EC

Typ ML PRO EC	150/750EC	160/800EC	200/1300 EC	250/1700EC	250/2100EC	280/2400EC	315/2900EC	355/3300EC	355/4700EC	400/5700EC
wyłącznik serwisowy	GS 03	GS 03	GS 03	GS 03	GS 03	GS 03	GS 03	GS 03	GS 03	GS 03
potencjometr	MTP 10 / MTV-010	MTP 10 / MTV-010	MTP 10 / MTV-010	MTP 10 / MTV-010	MTP 10 / MTV-010	MTP 10 / MTV-010	MTP 10 / MTV-010	MTP 10 / MTV-010	MTP 10 / MTV-010	MTP 10 / MTV-010
regulator stałego ciśnienia	CON P-1000	CON P-1000	CON P-1000	CON P-1000	CON P-1000	CON P-1000	CON P-1000	CON P-1000	CON P-1000	CON P-1000
klamra montażowa	OFK 150	OFK 160	OFK 200	OFK 250	OFK 250	OFK 280	OFK 315	OFK 355	OFK 355	OFK 400
tłumik kanałowy prosty	-	SDS 160	SDS 200	SDS 250	SDS 250	-	SDS 315	SDS 355	SDS 355	SDS 400
tłumik kanałowy elastyczny	FLEXITEC 150	FLEXITEC 160	FLEXITEC 200	FLEXITEC 250	FLEXITEC 250	-	FLEXITEC 315	-	-	-
siatka ochronna	SG 150	SG 160	SG 200	SG 250	SG 250	-	SG 315	-	-	-
klapa zwrotna	RSK 150	RSK 160	RSK 200	RSK 250	RSK 250	-	RSK 315	RSK 355	RSK 355	RSK 400
filtr kanałowy EU3	FBM 150	FBM 160	FBM 200	FBM 250	FBM 250	-	FBM 315	FBM 355	FBM 355	FBM 400
kasetka filtru kieszeniowego	FBB 150	FBB 160	FBB 200	FBB 250	FBB 250	-	FBB 315	FBB 355	FBB 355	FBB 400

dane techniczne

Typ	\dot{V}_{max} [m ³ /h]	Δp_{max} [Pa]	P_{max} [W]	$U_n / U_{ster.}$ [V] / [V]	I_{max} [A]	RPM_{max} [1/min]	L_{WA} [dB(A)]	L_{pA} [dB(A)]	t_{max} [°C]	m	nr katalogowy
ML PRO 150/750EC	780	420	67	230, 1~ / 0-10	0,60	3790	56	49	45	2,4	12858800
ML PRO 160/800EC	810	430	73	230, 1~ / 0-10	0,65	3730	55	48	45	2,6	12858600
ML PRO 200/1300 EC	1300	440	121	230, 1~ / 0-10	1,00	2970	62	55	45	3,2	13056100
ML PRO 250/1700EC	1780	510	179	230, 1~ / 0-10	1,49	3110	66	59	45	5,7	12895400
ML PRO 250/2100EC	2175	770	304	230, 1~ / 0-10	2,10	3700	67	60	45	4,0	13049100
ML PRO 280/2400EC	2440	630	267	230, 1~ / 0-10	1,86	3170	75	68	45	5,5	13070100
ML PRO 315/2900EC	2960	600	282	230, 1~ / 0-10	1,96	2800	69	61	45	6,8	13070800
ML PRO 355/3300EC	3320	450	261	230, 1~ / 0-10	1,82	2170	63	56	35	8,7	13071200
ML PRO 355/4700EC	4790	930	731	230, 1~ / 0-10	3,4	3010	65	58	60	9,8	13366600
ML PRO 400/5700EC	5700	870	729	230, 1~ / 0-10	3,4	2620	64	57	60	11,6	13366800

wymiary

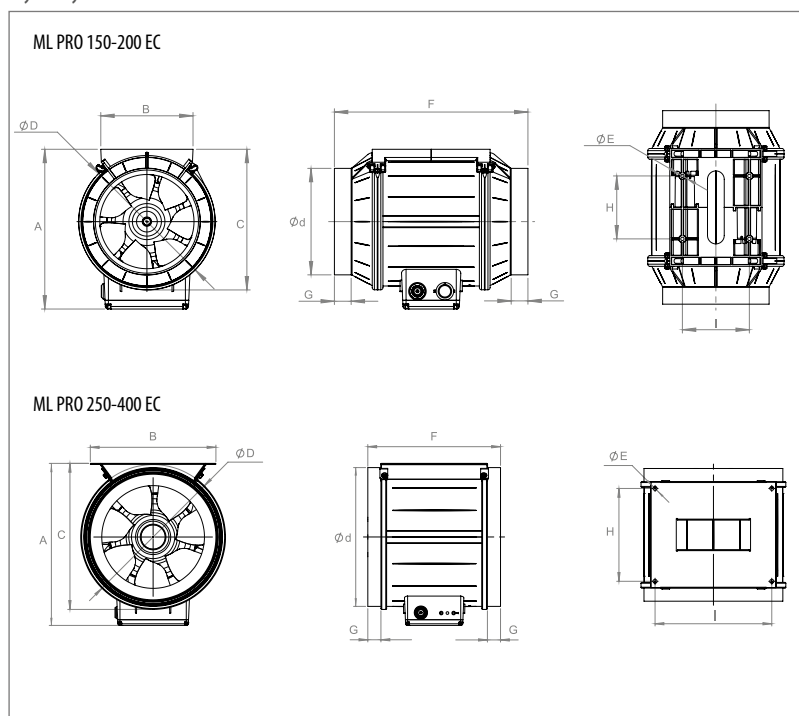

schemat elektryczny

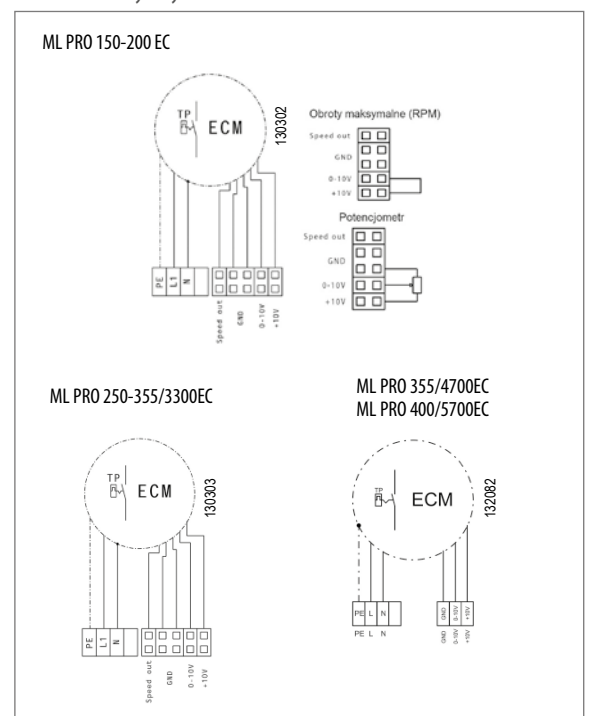

Typ	A [mm]	B [mm]	C [mm]	$\varnothing d$ [mm]	$\varnothing D$ [mm]	$\varnothing E$ [mm]	F [mm]	G [mm]	H [mm]	I [mm]
ML PRO 150/750EC	238,5	137,7	210,1	149,0	204,0	4 x 5	309,0	25,0	94,0	100,0
ML PRO 160/800EC	238,5	137,7	210,1	149,0	204,0	4 x 5	289,0	25,0	94,0	100,0
ML PRO 200/1300 EC	280,2	163,0	252,0	199,0	245,8	4 x 5	325,0	25,0	120,0	125,0
ML PRO 250/1700EC	299,4	169,7	268,0	248,9	263,4	4 x 5	215,0	25,0	80,0	125,0
ML PRO 250/2100EC	299,4	169,7	268,0	248,9	263,4	4 x 5	215,0	25,0	80,0	125,0
ML PRO 280/2400EC	327,6	258,3	295,6	274,3	292,3	4 x 9	280,0	29,6	195,0	234,0
ML PRO 315/2900EC	366,4	284,1	330,2	313,9	327,3	4 x 9	300,0	29,7	210,0	264,0
ML PRO 355/3300EC	401,0	316,0	365,0	353,8	367,2	4 x 9	325,0	49,7	200,0	295,0
ML PRO 355/4700EC	401,0	316,0	365,0	353,8	367,0	4 x 9	325,0	49,7	200,0	295,0
ML PRO 400/5700EC	452,0	350,0	410,0	398,8	411,0	4 x 9	350,0	49,0	225,0	330,0

charakterystyki pracy

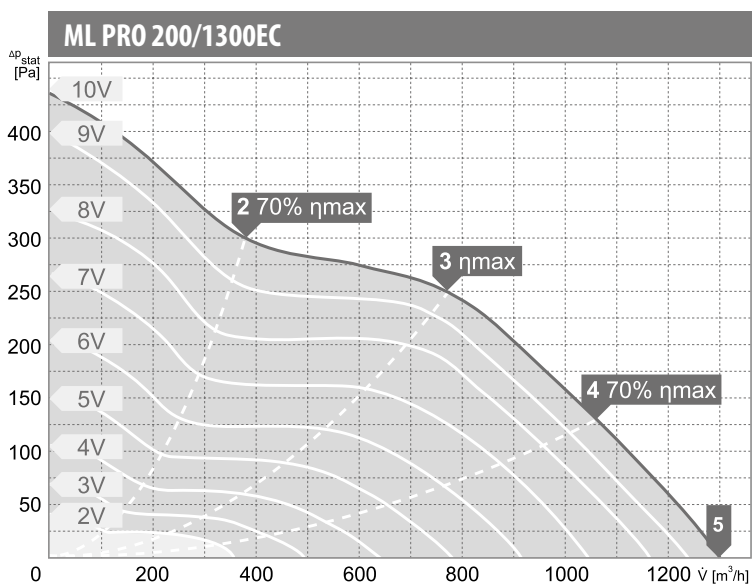
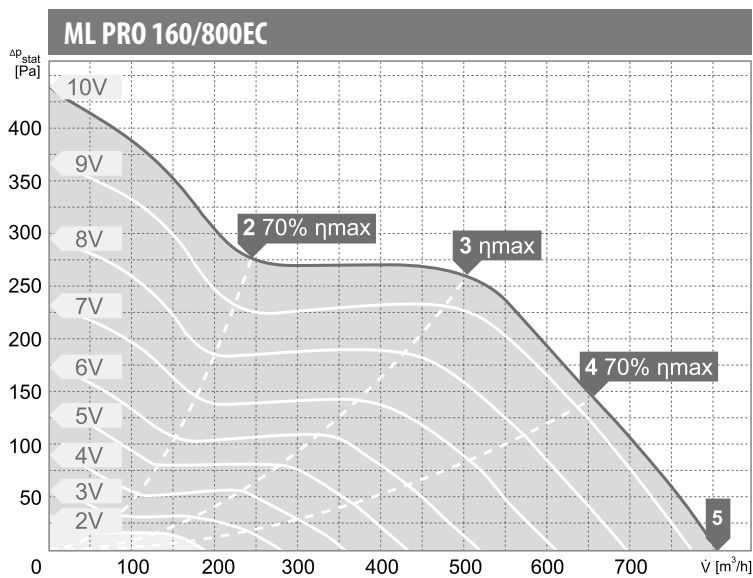
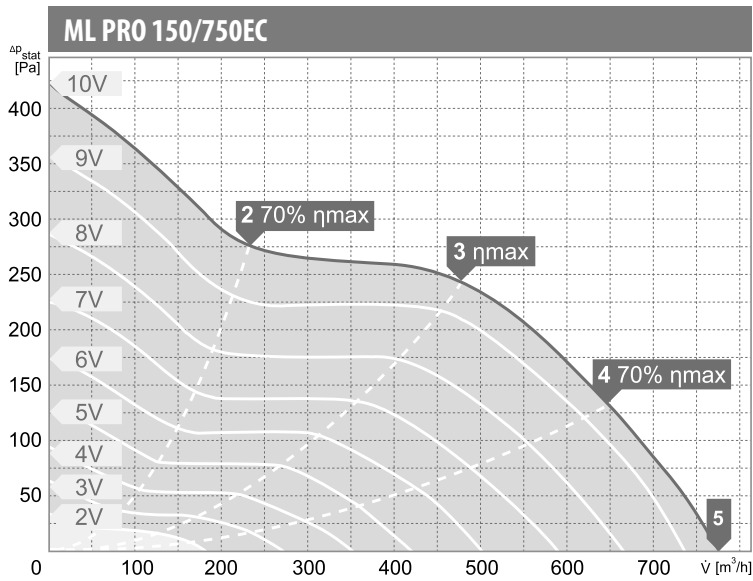

wartości mocy akustycznej L_{WA} [dB(A)]
dla poszczególnych częstotliwości pasm oktaowych [Hz]

Pkt. Pracy	tot	Częstotliwości pasm oktaowych [Hz]							
		63	125	250	500	1000	2000	4000	8000
L_{WA} wlot [dB(A)]									
2	71	43	57	60	67	65	63	58	50
3	74	40	53	62	71	68	66	60	52
4	74	33	43	59	69	69	68	63	56
5	74	31	43	57	68	69	70	64	58
L_{WA} wylot [dB(A)]									
2	72	46	59	61	67	68	64	62	53
3	75	42	51	62	68	71	68	65	57
4	76	41	45	62	67	72	69	67	60
5	77	40	44	61	67	73	71	68	61
L_{WA} od obudowy [dB(A)]									
2	57	45	49	44	48	51	53	47	35
3	56	40	39	44	47	50	53	46	36
4	56	34	32	41	45	50	53	47	37
5	57	35	32	41	44	50	55	48	39

Pkt. Pracy	tot	Częstotliwości pasm oktaowych [Hz]							
		63	125	250	500	1000	2000	4000	8000
L_{WA} wlot [dB(A)]									
2	71	43	58	59	67	66	64	59	51
3	72	33	44	58	67	67	66	61	56
4	73	29	40	56	68	67	68	63	58
5	73	29	40	54	64	67	69	64	59
L_{WA} wylot [dB(A)]									
2	74	43	58	62	68	69	66	63	54
3	75	37	49	61	68	71	68	66	58
4	75	34	44	59	66	72	69	67	60
5	76	35	46	60	66	73	71	68	62
L_{WA} od obudowy [dB(A)]									
2	57	44	48	44	48	50	52	46	35
3	55	39	34	42	46	49	52	45	36
4	55	35	28	39	44	49	52	45	37
5	56	35	30	39	43	50	53	46	38

Pkt. Pracy	tot	Częstotliwości pasm oktaowych [Hz]							
		63	125	250	500	1000	2000	4000	8000
L_{WA} wlot [dB(A)]									
2	76	50	63	65	73	71	67	61	53
3	77	41	58	67	73	72	70	64	57
4	76	39	48	67	71	70	69	65	59
5	76	36	47	64	71	71	70	66	61
L_{WA} wylot [dB(A)]									
2	78	51	64	67	73	73	69	64	56
3	79	41	59	69	73	75	71	68	59
4	78	40	49	72	70	73	71	68	60
5	79	39	50	69	71	75	73	70	62
L_{WA} od obudowy [dB(A)]									
2	62	47	53	51	55	58	56	48	38
3	62	40	42	51	54	58	57	48	40
4	61	45	36	52	52	56	56	48	40
5	62	36	37	50	54	57	57	50	41

charakterystyki pracy

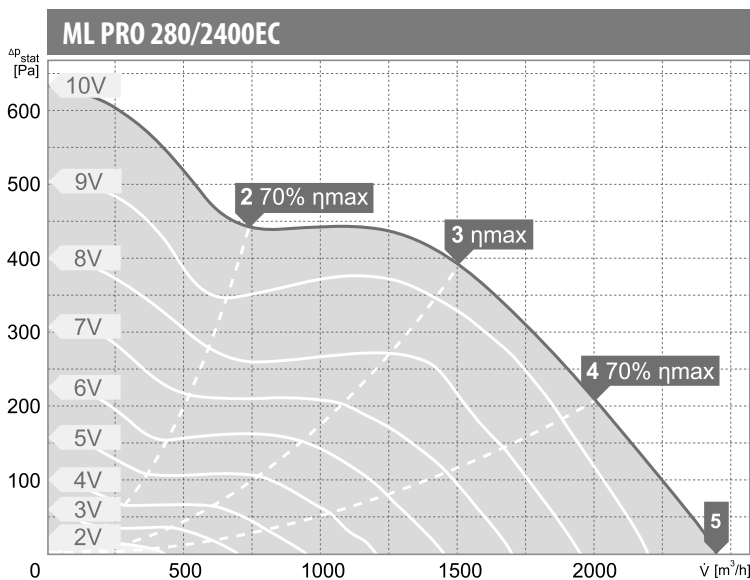
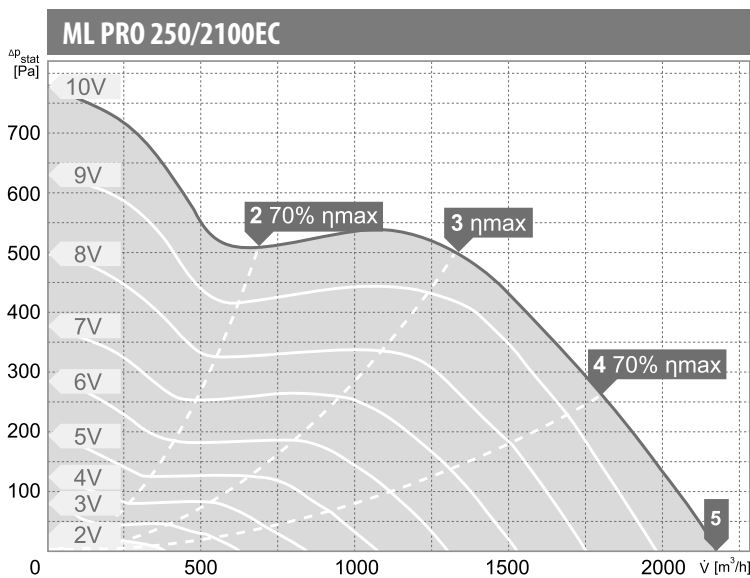
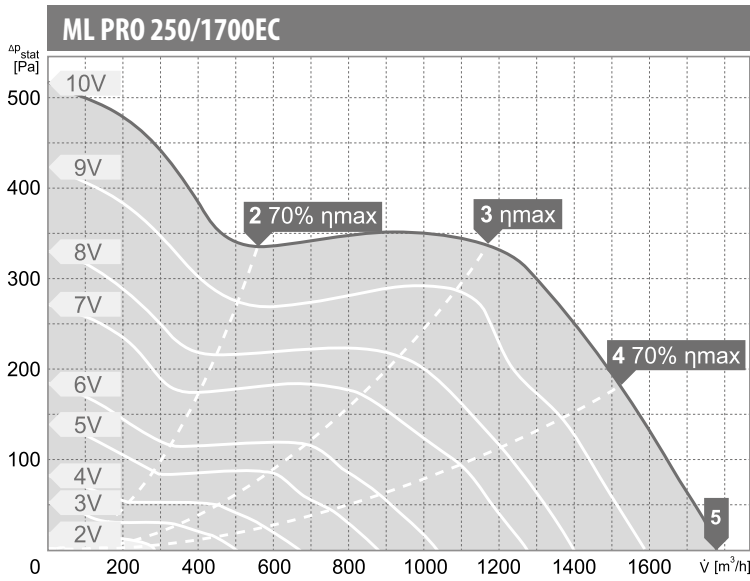

wartości mocy akustycznej L_{WA} [dB(A)]
dla poszczególnych częstotliwości pasm oktaowych [Hz]

Pkt. Pracy	Częstotliwości pasm oktaowych [Hz]								
	tot	63	125	250	500	1000	2000	4000	8000
L_{WA} wlot [dB(A)]									
2	77	55	65	65	70	73	70	66	57
3	76	52	62	64	70	72	70	65	55
4	76	37	43	56	65	72	71	67	61
5	78	41	46	58	68	74	72	69	64
L_{WA} wylot [dB(A)]									
2	79	54	63	65	71	76	74	65	57
3	79	50	61	64	71	76	73	65	57
4	79	42	41	58	67	76	73	67	62
5	80	45	44	59	69	77	75	69	64
L_{WA} od obudowy [dB(A)]									
2	67	54	56	50	52	65	57	48	39
3	66	52	52	49	52	65	56	47	37
4	69	43	40	45	52	69	54	47	39
5	67	45	37	44	51	67	55	49	41

Pkt. Pracy	Częstotliwości pasm oktaowych [Hz]								
	tot	63	125	250	500	1000	2000	4000	8000
L_{WA} wlot [dB(A)]									
2	83	57	70	71	76	78	76	72	63
3	82	57	71	71	75	77	75	71	61
4	79	34	46	58	70	74	73	72	66
5	81	38	49	61	72	77	75	74	69
L_{WA} wylot [dB(A)]									
2	86	58	70	72	77	83	81	74	66
3	86	55	69	72	77	83	80	72	65
4	83	34	46	58	72	79	78	72	67
5	85	38	48	60	75	81	79	75	70
L_{WA} od obudowy [dB(A)]									
2	68	56	59	55	60	63	63	54	44
3	67	54	58	55	59	62	62	52	41
4	64	45	39	49	59	61	57	50	42
5	65	42	40	47	59	62	58	52	44

Pkt. Pracy	Częstotliwości pasm oktaowych [Hz]								
	tot	63	125	250	500	1000	2000	4000	8000
L_{WA} wlot [dB(A)]									
2	82	56	67	68	75	79	74	69	60
3	82	55	68	70	76	79	74	68	58
4	80	42	47	63	69	78	72	70	64
5	82	39	49	61	72	80	75	72	66
L_{WA} wylot [dB(A)]									
2	84	56	68	71	78	81	76	71	62
3	83	46	61	70	77	81	75	70	62
4	82	42	48	67	75	79	75	71	65
5	84	40	49	63	76	82	77	73	68
L_{WA} od obudowy [dB(A)]									
2	76	53	55	54	57	75	60	48	39
3	75	49	52	54	57	74	59	46	37
4	73	45	41	47	55	72	56	44	35
5	75	38	41	44	56	75	59	48	39

charakterystyki pracy

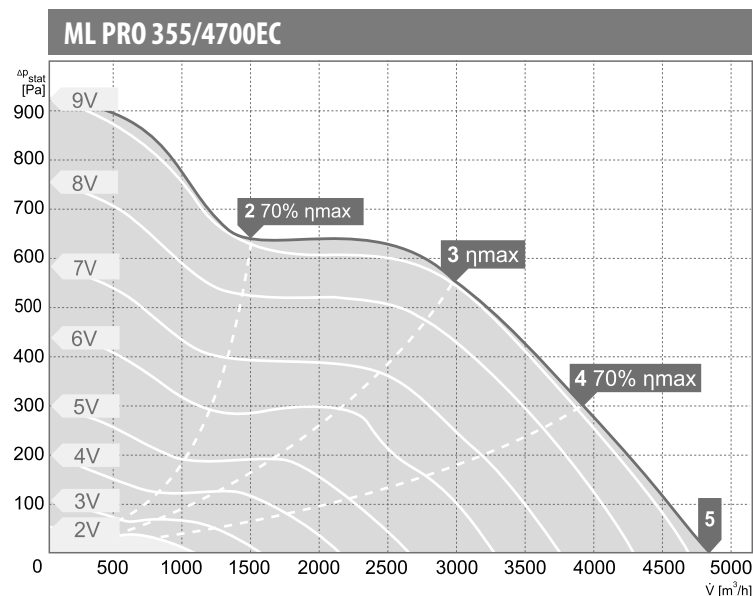
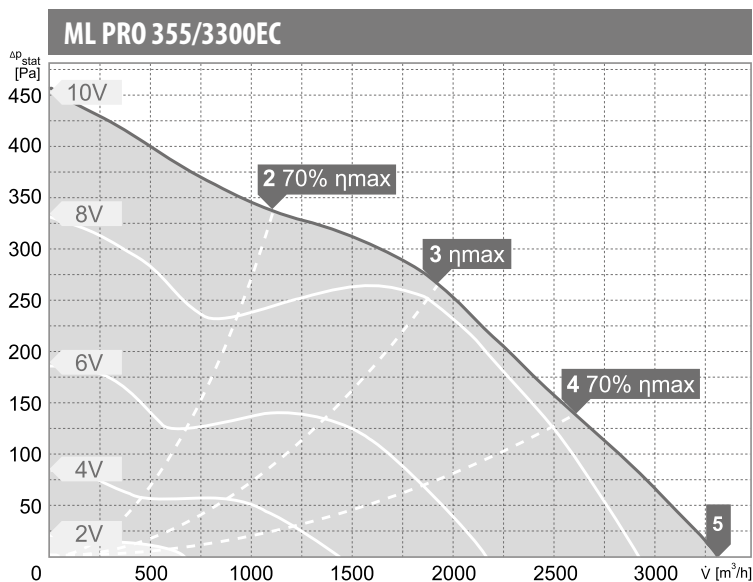
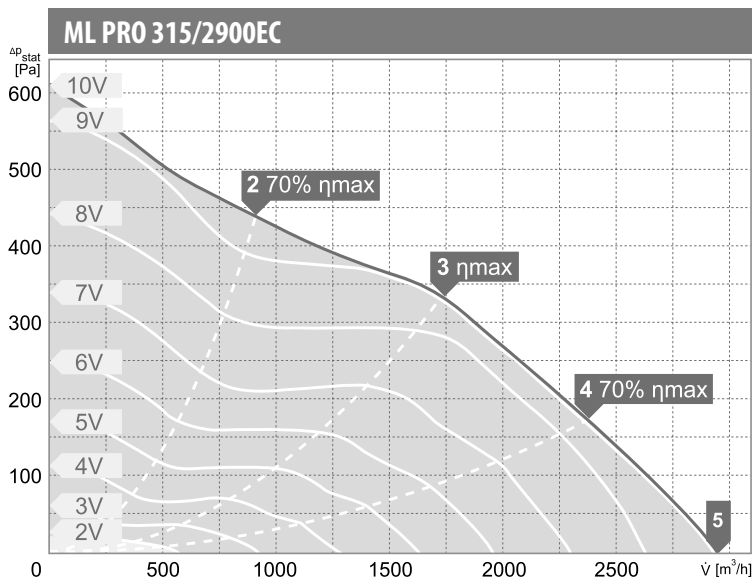

wartości mocy akustycznej L_{WA} [dB(A)]
dla poszczególnych częstotliwości pasm oktaowych [Hz]

Pkt. Pracy	tot	Częstotliwości pasm oktaowych [Hz]							
		63	125	250	500	1000	2000	4000	8000
L_{WA} wlot [dB(A)]									
2	80	56	67	69	74	76	73	68	58
3	77	36	53	66	69	72	70	70	61
4	76	33	46	60	67	72	70	70	61
5	79	34	48	63	70	74	73	72	64
L_{WA} wylot [dB(A)]									
2	83	56	68	71	78	79	75	69	59
3	80	39	54	69	74	76	73	69	60
4	79	31	47	67	73	75	72	70	62
5	82	33	48	64	76	77	74	72	65
L_{WA} od obudowy [dB(A)]									
2	73	56	55	53	57	72	58	45	38
3	69	39	39	49	57	68	54	44	34
4	69	29	33	45	59	68	53	44	33
5	71	33	36	46	56	71	56	46	37

Pkt. Pracy	tot	Częstotliwości pasm oktaowych [Hz]							
		63	125	250	500	1000	2000	4000	8000
L_{WA} wlot [dB(A)]									
2	78	55	63	66	75	72	70	64	53
3	73	32	50	59	68	67	66	65	55
4	72	27	45	56	65	66	66	65	55
5	75	29	46	57	69	69	69	68	59
L_{WA} wylot [dB(A)]									
2	81	55	65	70	77	77	72	66	55
3	76	34	50	63	71	72	68	66	57
4	74	27	44	59	69	70	67	66	56
5	78	32	46	61	72	73	70	69	59
L_{WA} od obudowy [dB(A)]									
2	64	54	51	52	59	60	51	42	34
3	63	31	35	47	59	60	46	40	31
4	63	28	34	47	60	59	45	39	28
5	62	28	35	46	58	60	49	42	31

Pkt. Pracy	tot	Częstotliwości pasm oktaowych [Hz]							
		63	125	250	500	1000	2000	4000	8000
L_{WA} wlot [dB(A)]									
2	87	69	73	77	82	82	80	76	66
3	84	59	62	72	78	79	77	74	65
4	81	53	50	68	74	75	75	74	67
5	84	57	50	70	75	78	77	76	71
L_{WA} wylot [dB(A)]									
2	90	67	74	77	85	86	81	76	66
3	88	63	69	76	84	84	80	75	65
4	85	47	50	72	79	80	78	75	68
5	87	60	51	72	81	83	81	78	72
L_{WA} od obudowy [dB(A)]									
2	71	61	62	59	66	67	61	53	42
3	65	41	44	51	60	62	56	51	41
4	64	37	41	48	59	61	56	51	43
5	68	40	41	51	64	64	59	53	46

charakterystyki pracy

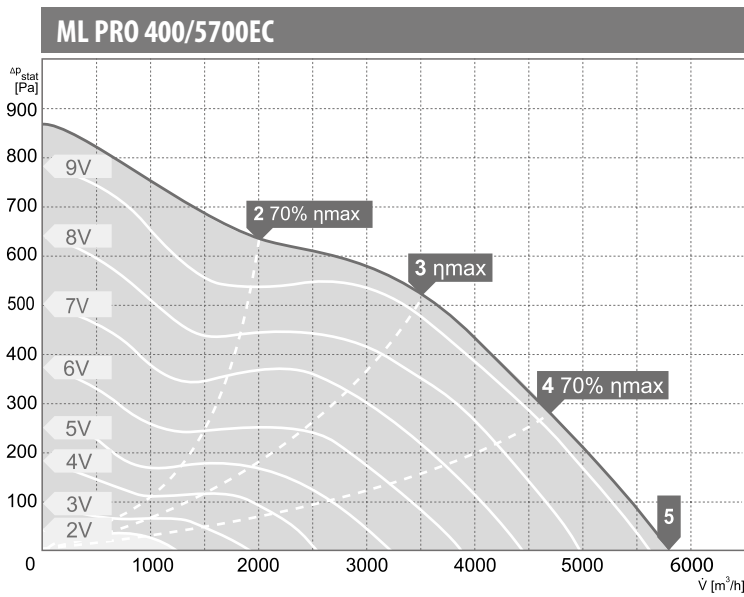

wartości mocy akustycznej L_{WA} [dB(A)]
dla poszczególnych częstotliwości pasm oktaowych [Hz]

Pkt. Pracy	Częstotliwości pasm oktaowych [Hz]								
	tot	63	125	250	500	1000	2000	4000	8000
L_{WA} wlot [dB(A)]									
2	86	65	73	76	81	82	79	73	64
3	81	44	58	71	75	76	74	71	64
4	79	36	49	68	72	73	72	71	63
5	82	38	51	69	75	77	75	75	68
L_{WA} wylot [dB(A)]									
2	90	66	73	77	85	86	81	76	67
3	86	43	57	74	81	81	76	73	65
4	85	35	50	75	80	80	76	73	64
5	86	38	52	74	81	82	79	76	70
L_{WA} od obudowy [dB(A)]									
2	69	64	59	57	61	63	55	47	41
3	64	52	53	54	58	59	51	44	38
4	58	38	41	47	53	55	48	42	34
5	62	39	41	50	56	59	52	46	40