



konstrukcja

Promieniowy wentylator kanałowy. Obudowa wykonana z tłoczonej blachy stalowej cynkowanej galwanicznie i lakierowanej epoksydowo na kolor szary (RAL 7035). Obudowa posiada znormalizowane króćce przyłączeniowe z tolerancją ujemną (nypłowe) do podłączenia w systemie okrągłych kanałów wentylacyjnych. Na obudowie przymocowano puszkę przyłączeniową.

wirnik

Wyważany dynamicznie wirnik typu B stanowi integralną część silnika (tzw. silnik z wirującą obudową). Łopatkę pochyloną do tyłu wykonaną z tworzywa sztucznego.

napęd i sterowanie

Jednofazowy, asynchroniczny silnik elektryczny 230V, 50Hz z wirującą obudową. Silniki posiadają zintegrowane zabezpieczenie termiczne i są przystosowane do napięciowej regulacji prędkości obrotowej w zakresie od 80 do 230V. Stopień ochrony IPX4. Klasa izolacji F.

maksymalna temperatura pracy

50 ÷ 70°C - w zależności od wybranego modelu.

zastosowanie

Transport czystego, niezapyłonego powietrza w instalacjach wentylacyjnych do i z pomieszczeń w obiektach: mieszkalnych, biurowych, przemysłowych i użyteczności publicznej.

tablica doboru akcesoriów dla danego wentylatora RM

Typ RM	100/240	125/300	150/450	160/450	200/800
wyłącznik serwisowy	GS 01	GS 01	GS 01	GS 01	GS 01
płynny regulator obrotów (tyrystorowy)	ETX 15	ETX 15	ETX 15	ETX 15	ETX 15
5-bieg. reg. obrotów (transformatorowy)	STR-1-15L22	STR-1-15L22	STR-1-15L22	STR-1-15L22	STR-1-15L22
autotransformator do zab. w szafie ster.	ATR-1-15L25	ATR-1-15L25	ATR-1-15L25	ATR-1-15L25	ATR-1-15L25
klamra montażowa	OFK 100	OFK 125	OFK 150	OFK 160	OFK 200
tłumik kanałowy prosty	SDS 100	SDS 125	-	SDS 160	SDS 200
tłumik kanałowy elastyczny	FLEXITEC 100	FLEXITEC 125	FLEXITEC 150	FLEXITEC 160	FLEXITEC 200
siatka ochronna	SG 100	SG 125	SG 150	SG 160	SG 200
klapa zwrotna	RSK 100	RSK 125	RSK 150	RSK 160	RSK 200
filtr kanałowy EU3	FBM 100	FBM 125	FBM 150	FBM 160	FBM 200
kaseta filtra kieszeniowego	FBB 100	FBB 125	FBB 150	FBB 160	FBB 200
przepustnica soczewkowa	IRIS 100	IRIS 125	-	IRIS 160	IRIS 200
uchwyt montażowy	MRS 01	MRS 01	MRS 01	MRS 01	MRS 02

Typ RM	200/1000	250/900	250/1100	315/1200
wyłącznik serwisowy	GS 01	GS 01	GS 01	GS 01
płynny regulator obrotów (tyrystorowy)	ETX 15	ETX 15	ETX 15	ETX 15
5-bieg. reg. obrotów (transformatorowy)	STR-1-15L22	STR-1-15L22	STR-1-15L22	STR-1-15L22
autotransformator do zab. w szafie ster.	ATR-1-15L25	ATR-1-15L25	ATR-1-15L25	ATR-1-15L25
klamra montażowa	OFK 200	OFK 250	OFK 250	OFK 315
tłumik kanałowy prosty	SDS 200	SDS 250	SDS 250	SDS 315
tłumik kanałowy elastyczny	FLEXITEC 200	FLEXITEC 250	FLEXITEC 250	FLEXITEC 315
siatka ochronna	SG 200	SG 250	SG 250	SG 315
klapa zwrotna	RSK 200	RSK 250	RSK 250	RSK 315
filtr kanałowy EU3	FBM 200	FBM 250	FBM 250	FBM 315
kaseta filtra kieszeniowego	FBB 200	FBB 250	FBB 250	FBB 315
przepustnica soczewkowa	IRIS 200	IRIS 250	IRIS 250	IRIS 315
uchwyt montażowy	MRS 02	MRS 02	MRS 02	MRS 02

Akcesoria

-  **GS**
wyłącznik serwisowy
str. nr 548
-  **ETX**
płynny reg. obrotów (tyrystorowy)
str. nr 528
-  **STR-1**
5-bieg. reg. ob. (transformatorowy)
str. nr 533
-  **ATR-1**
autotransf. do zab. w szafie ster.
str. nr 532
-  **OFK**
klamra montażowa
str. nr 94
-  **SDS**
tłumik kanałowy prosty
str. nr 97
-  **FLEXITEC**
tłumik kanałowy elastyczny
str. nr 96
-  **SG**
siatka ochronna
str. nr 97
-  **RSK**
klapa zwrotna
str. nr 94
-  **FBM**
filtr kanałowy EU3
str. nr 93
-  **FBB**
kaseta filtra kieszeniowego
str. nr 93
-  **IRIS**
przepustnica soczewkowa
str. nr 95
-  **MRS**
uchwyt montażowy
str. nr 98

dane techniczne

Typ	\dot{V}_{max} [m ³ /h]	Δp_{max} [Pa]	P_{max} [W]	U [V]	I_{max} [A]	RPM _{max} [1/min]	t_{max} [°C]	L_{WA} [dB(A)]	L_{pA} [dB(A)]	m [kg]	nr katalogowy
RM 100/240	250	235	28	230	0,2	2710	60	48	41	2,8	14335100
RM 125/300	300	240	28	230	0,2	2730	60	48	41	2,7	14335400
RM 150/450	440	360	48	230	0,3	2760	70	49	42	3,1	13498400
RM 160/450	460	360	49	230	0,3	2750	70	45	38	3	13498600
RM 200/800	810	460	100	230	0,5	2720	70	56	49	4,2	10420900
RM 200/1000	1040	560	154	230	0,7	2910	70	61	54	5,1	13639500
RM 250/900	890	480	100	230	0,5	2720	60	58	51	4,3	10421300
RM 250/1100	1090	570	161	230	0,7	2910	60	59	52	5,1	13639800
RM 315/1200	1170	580	162	230	0,9	2890	60	56	49	5,7	13640000

wymiary

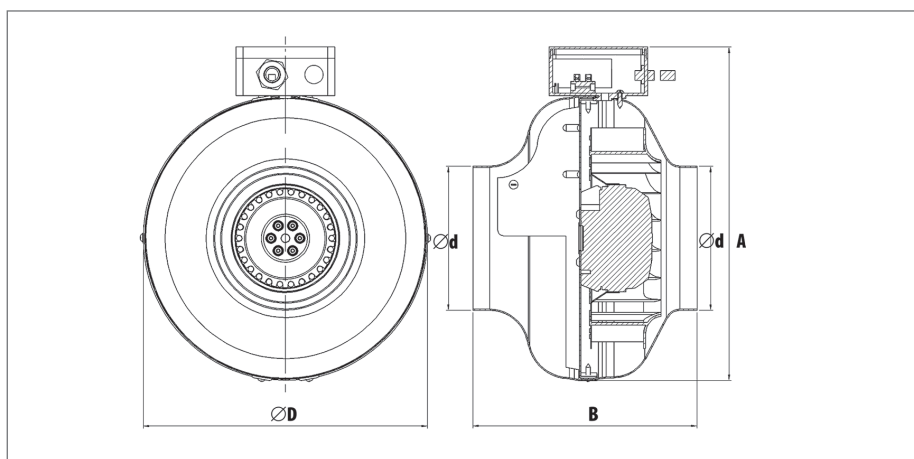

Typ	A [mm]	B [mm]	$\varnothing d$ [mm]	$\varnothing D$ [mm]
RM 100/240	287	209	99	245
RM 125/300	287	193	124	245
RM 150/450	312	191	149	270
RM 160/450	310	205	159	270
RM 200/800	386	227	199	344
RM 200/1000	386	243,5	199	344
RM 250/900	386	235	249	344
RM 250/1100	386	243	249	344
RM 315/1200	444	253,5	314	402

schematy elektryczne

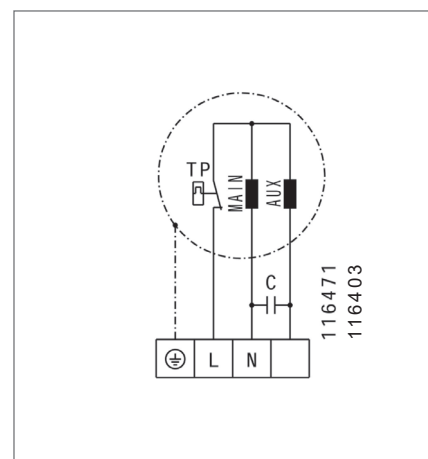

charakterystyki pracy

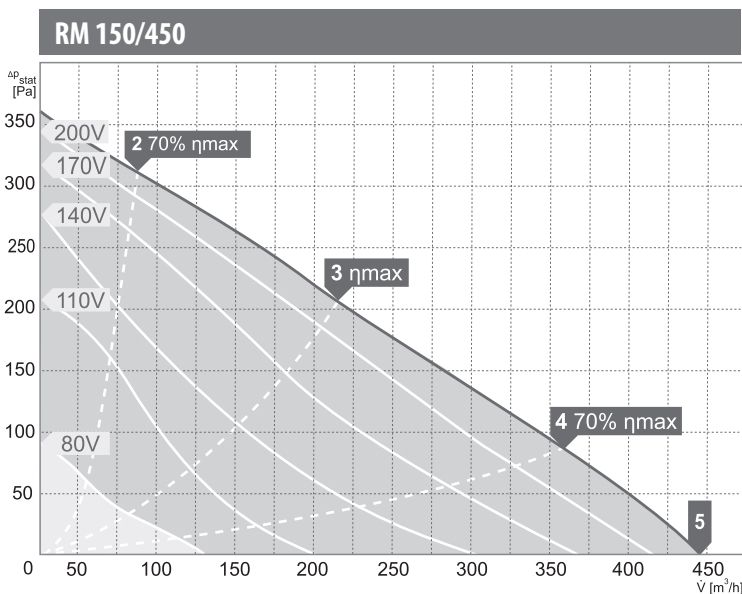
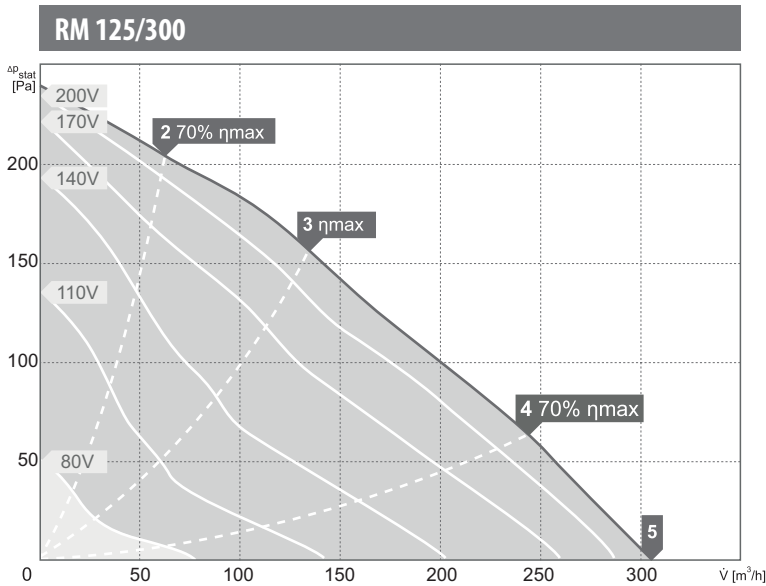
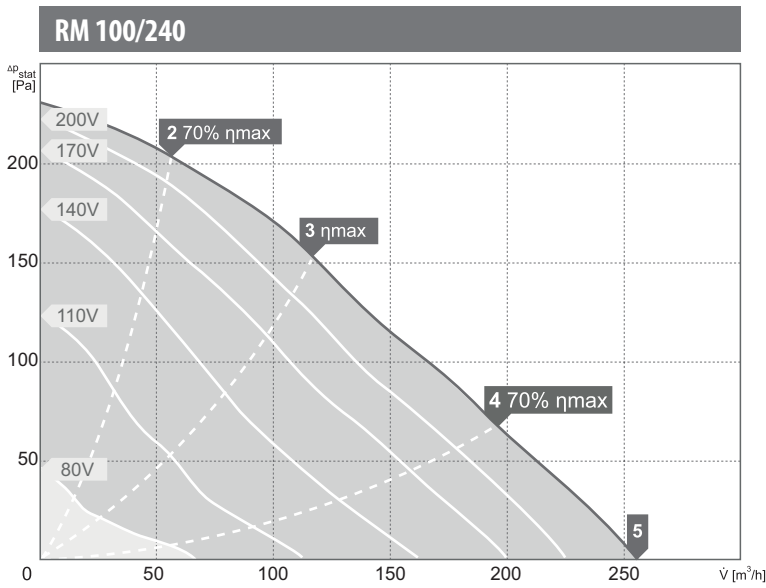

wartości mocy akustycznej L_{WA} [dB(A)]
dla poszczególnych częstotliwości pasm oktaowych [Hz]

Pkt. Pracy	Częstotliwości pasm oktaowych [Hz]								
	tot	63	125	250	500	1000	2000	4000	8000
L_{WA} wlot [dB(A)]									
2	59	33	38	54	52	54	51	44	39
3	59	33	38	54	52	54	51	44	38
4	62	34	42	58	54	55	53	46	35
5	64	36	44	61	57	57	55	49	38
L_{WA} wylot [dB(A)]									
2	59	32	42	57	45	51	50	44	35
3	60	32	42	58	46	51	50	44	35
4	65	33	46	64	49	51	52	45	33
5	66	33	47	65	52	53	54	48	35
L_{WA} od obudowy [dB(A)]									
2	47	26	30	35	38	44	41	36	27
3	48	25	31	34	38	44	42	37	28
4	48	28	31	34	38	45	42	38	29
5	48	31	31	36	39	45	43	38	30

Pkt. Pracy	Częstotliwości pasm oktaowych [Hz]								
	tot	63	125	250	500	1000	2000	4000	8000
L_{WA} wlot [dB(A)]									
2	59	33	38	54	52	54	51	44	39
3	59	33	38	54	52	54	51	44	38
4	62	34	42	58	54	55	53	46	35
5	64	36	44	61	57	57	55	49	38
L_{WA} wylot [dB(A)]									
2	59	32	42	57	45	51	50	44	35
3	60	32	42	58	46	51	50	44	35
4	65	33	46	64	49	51	52	45	33
5	66	33	47	65	52	53	54	48	35
L_{WA} od obudowy [dB(A)]									
2	47	26	30	35	38	44	41	36	27
3	48	25	31	34	38	44	42	37	28
4	48	28	31	34	38	45	42	38	29
5	48	31	31	36	39	45	43	38	30

Pkt. Pracy	Częstotliwości pasm oktaowych [Hz]								
	tot	63	125	250	500	1000	2000	4000	8000
L_{WA} wlot [dB(A)]									
2	63	39	48	50	58	58	57	54	45
3	62	34	43	48	55	57	56	53	44
4	64	32	42	49	57	59	59	56	47
5	66	35	44	51	59	61	61	59	48
L_{WA} wylot [dB(A)]									
2	64	40	50	57	57	57	57	53	44
3	62	35	45	55	54	56	56	52	43
4	63	33	43	57	55	57	57	53	44
5	66	34	45	59	57	59	60	57	47
L_{WA} od obudowy [dB(A)]									
2	51	35	39	40	43	47	44	39	28
3	49	34	32	38	43	45	43	37	27
4	49	32	31	38	41	44	43	37	27
5	51	33	31	40	42	46	46	41	30

charakterystyki pracy

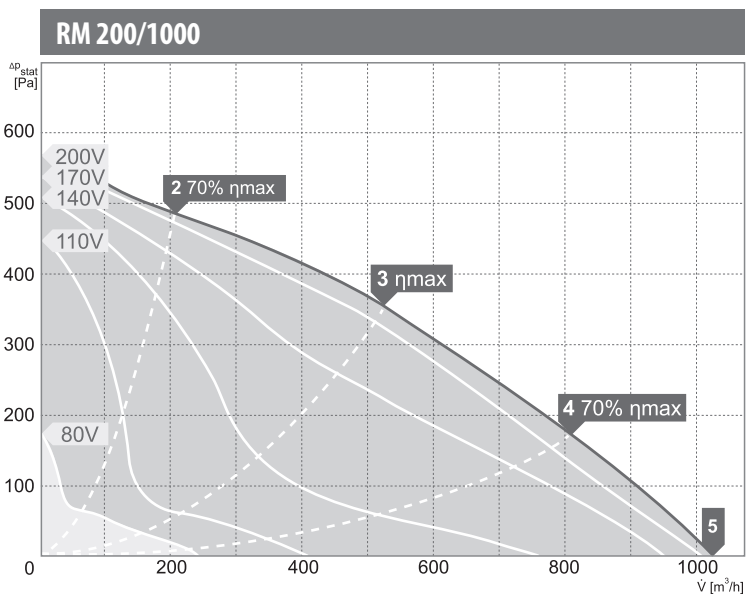
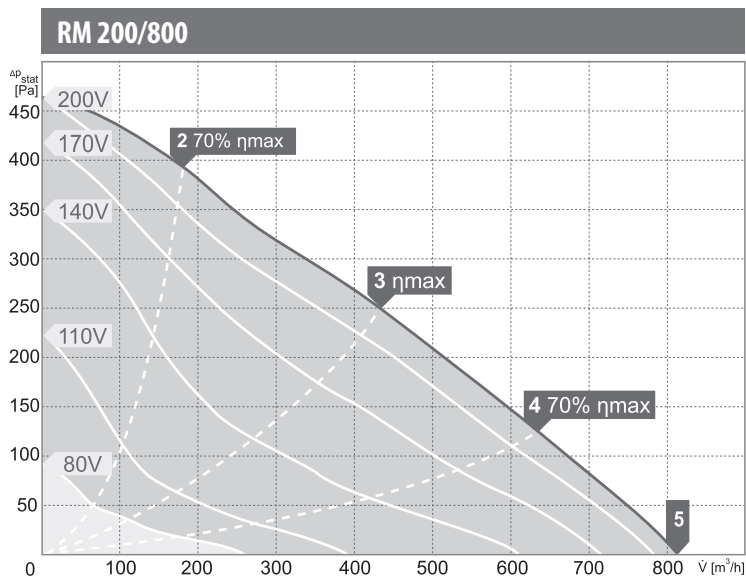
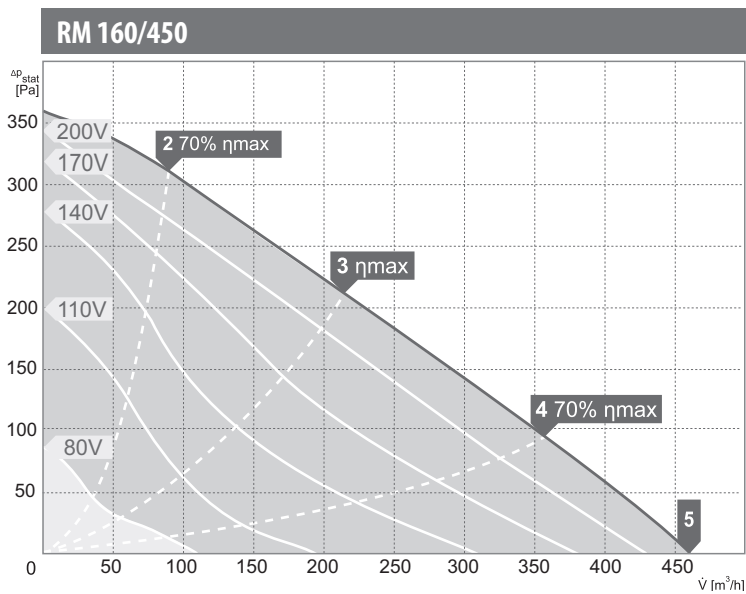

wartości mocy akustycznej L_{WA} [dB(A)]

dla poszczególnych częstotliwości pasm oktaowych [Hz]

Pkt. Pracy	tot	Częstotliwości pasm oktaowych [Hz]							
		63	125	250	500	1000	2000	4000	8000
L_{WA} wlot [dB(A)]									
2	63	36	49	51	57	58	57	54	46
3	62	32	44	48	54	57	56	53	45
4	63	31	45	50	56	57	57	57	51
5	67	32	47	52	58	59	61	61	56
L_{WA} wylot [dB(A)]									
2	64	39	49	57	55	58	57	52	45
3	62	36	45	56	53	57	56	51	44
4	64	34	45	60	54	57	56	53	48
5	65	36	48	60	56	59	58	57	52
L_{WA} od obudowy [dB(A)]									
2	50	32	37	40	42	46	44	38	28
3	45	24	28	35	37	41	39	32	21
4	48	30	33	38	39	44	42	38	31
5	51	31	33	40	41	46	45	41	38

Pkt. Pracy	tot	Częstotliwości pasm oktaowych [Hz]							
		63	125	250	500	1000	2000	4000	8000
L_{WA} wlot [dB(A)]									
2	71	35	54	61	65	66	63	58	47
3	71	35	53	61	65	67	63	58	47
4	71	34	47	60	66	67	63	61	49
5	73	36	47	62	67	69	65	65	54
L_{WA} wylot [dB(A)]									
2	71	36	57	64	62	65	64	60	47
3	70	35	56	63	62	65	64	59	47
4	71	35	51	63	62	66	64	62	48
5	73	36	50	64	62	68	67	66	53
L_{WA} od obudowy [dB(A)]									
2	59	43	43	50	52	53	52	50	42
3	56	46	38	49	49	50	49	47	37
4	56	36	37	51	50	50	49	45	32
5	59	46	38	50	53	54	52	49	40

Pkt. Pracy	tot	Częstotliwości pasm oktaowych [Hz]							
		63	125	250	500	1000	2000	4000	8000
L_{WA} wlot [dB(A)]									
2	72	39	54	65	66	67	62	58	50
3	70	37	49	61	63	65	62	59	49
4	73	39	50	64	65	69	65	64	55
5	75	42	51	71	66	69	67	66	59
L_{WA} wylot [dB(A)]									
2	73	40	58	68	63	68	65	61	52
3	72	38	52	65	63	67	65	61	51
4	74	39	52	67	64	69	67	65	55
5	75	41	53	69	64	69	68	67	59
L_{WA} od obudowy [dB(A)]									
2	61	42	52	50	52	54	56	54	44
3	61	40	49	48	51	54	56	53	43
4	62	41	47	50	52	56	59	53	44
5	63	45	47	50	53	56	60	54	43

charakterystyki pracy

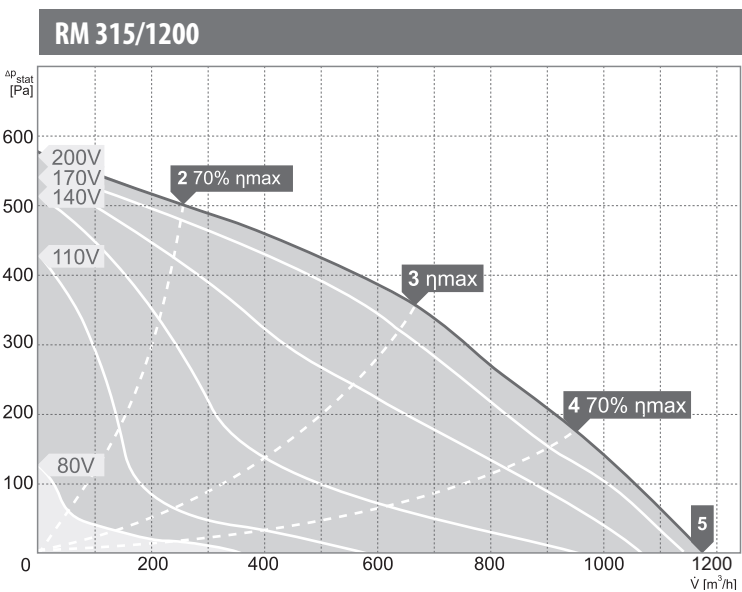
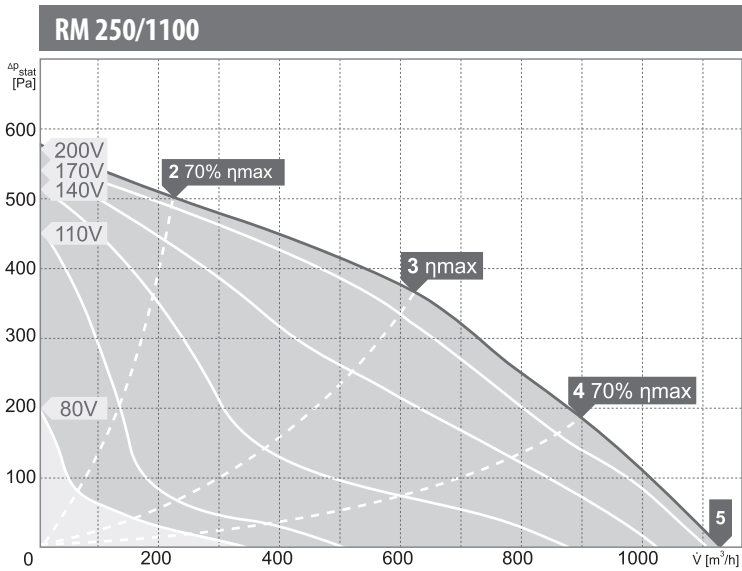
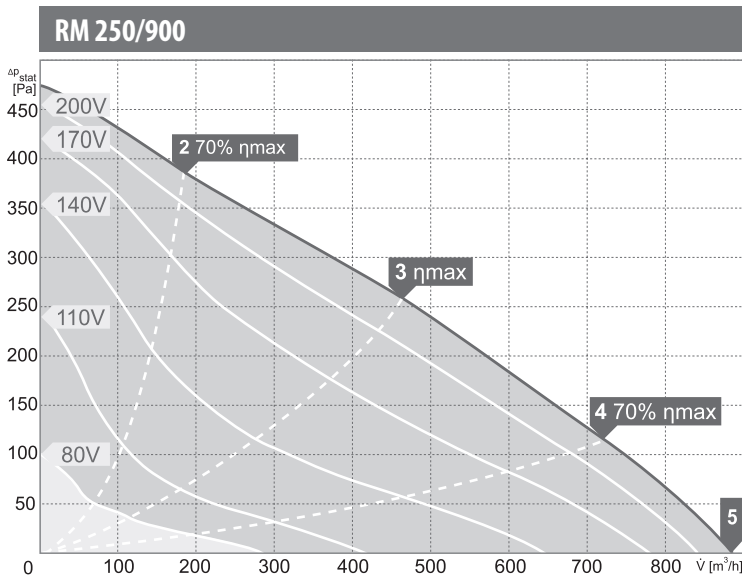

wartości mocy akustycznej L_{WA} [dB(A)]
dla poszczególnych częstotliwości pasm oktaowych [Hz]

Pkt. Pracy	Częstotliwości pasm oktaowych [Hz]								
	tot	63	125	250	500	1000	2000	4000	8000
L_{WA} wlot [dB(A)]									
2	72	37	53	62	67	67	63	63	56
3	71	36	49	59	65	66	63	63	57
4	73	36	50	60	66	68	65	67	61
5	75	38	52	63	68	70	67	68	65
L_{WA} wylot [dB(A)]									
2	74	39	56	67	68	69	67	64	56
3	74	40	53	63	66	69	68	63	56
4	75	38	52	64	67	71	69	67	62
5	77	40	54	66	69	72	71	68	64
L_{WA} od obudowy [dB(A)]									
2	59	40	44	44	52	54	54	48	42
3	58	40	42	43	51	54	53	47	40
4	61	39	42	44	52	56	57	49	43
5	62	40	44	47	54	57	58	51	45

Pkt. Pracy	Częstotliwości pasm oktaowych [Hz]								
	tot	63	125	250	500	1000	2000	4000	8000
L_{WA} wlot [dB(A)]									
2	70	39	55	62	65	65	62	58	50
3	68	37	48	58	60	64	61	59	49
4	72	36	50	65	64	68	64	64	56
5	74	38	51	65	66	68	67	66	61
L_{WA} wylot [dB(A)]									
2	73	40	58	66	67	68	65	61	53
3	71	38	49	63	65	65	64	61	51
4	75	38	51	68	67	68	68	66	57
5	76	38	52	68	69	69	70	69	61
L_{WA} od obudowy [dB(A)]									
2	60	44	46	48	53	55	54	53	44
3	59	40	48	47	50	54	53	50	39
4	61	40	47	47	53	56	56	50	39
5	62	43	47	49	55	57	57	52	43

Pkt. Pracy	Częstotliwości pasm oktaowych [Hz]								
	tot	63	125	250	500	1000	2000	4000	8000
L_{WA} wlot [dB(A)]									
2	71	46	54	62	65	67	61	58	50
3	68	38	44	57	58	64	60	62	49
4	72	40	48	63	63	68	63	65	55
5	74	41	50	66	65	69	65	66	62
L_{WA} wylot [dB(A)]									
2	74	45	58	68	68	68	65	62	54
3	70	36	47	61	62	64	64	63	52
4	74	39	53	66	67	68	68	68	59
5	76	40	54	67	68	69	69	70	63
L_{WA} od obudowy [dB(A)]									
2	59	48	47	48	52	54	54	47	37
3	56	40	46	45	47	50	51	47	35
4	59	43	44	46	51	54	55	49	39
5	60	41	44	47	51	54	57	51	42